

# SUPERIA

TECHNISCH HANDBOEK 2025





**superia**

## WARMTE, OP MAAT VAN ÚW COMFORTBEHOEFTE

**Vasco** is een totaalaanbieder van verwarmings- en ventilatieoplossingen met verkoopactiviteiten in Europa, maar ook in verre exportmarkten zoals Japan, VS, China en Nieuw Zeeland. Merken die tot Vasco behoren zijn: Vasco, Brugman en Superia.

Vasco is een toonaangevende producent van designradiatoren, ventilatie, vloerverwarming en koeling en is marktleider in badkamerradiatoren in Benelux.

Brugman en Superia zijn kwaliteitsmerken voor paneelradiatoren en behoren tot de absolute top in hun segment. Vasco ontwikkelt en produceert oplossingen voor een comfortabel binnenklimaat. Dit door een sterke focus op de individuele behoeften van de eindklant.

De zoektocht naar alternatieve materialen, innovatieve designs en vernieuwende productieprocessen, leverde Vasco al tal van internationale design awards op.

Het hoofdkantoor van Vasco is gevestigd in Dilsen (België). De productiebedrijven bevinden zich in Stříbro (Tsjechië), Plattling (Duitsland), Dilsen (België) en Legnica (Polen).

Vasco/Brugman/Superia telt 500 medewerkers.



## INHOUD

|  |              |
|--|--------------|
| PRODUCTIE & KWALITEIT                      | 6            |
| LAKAPPLICATIE                              | 7            |
| <b>HORIZONTALE RADIATOREN</b>              | <b>9</b>     |
| BESTEKTEKSTEN & TECHNISCHE TEKENINGEN      |              |
| STANDAARD                                  | 10           |
| KOMPAKT                                    | 12           |
| SUPER 6 UNIVERSEEL                         | 14           |
| SUPER 6 DESIGN                             | 16           |
| CENTRAL (GALVA)                            | 18           |
| CENTRAL DESIGN                             | 20           |
| CENTRAL LINE                               | 22           |
| AANSLUITINGEN                              | 24           |
| POSITIE OPHANGSTRIPPEN                     | 26           |
| <b>VERTICALE RADIATOREN</b>                | <b>27</b>    |
| BESTEKTEKSTEN & TECHNISCHE TEKENINGEN      |              |
| VERTI M KOMPAKT (GALVA)                    | 28           |
| VERTI M DESIGN                             | 30           |
| VERTI M LINE                               | 32           |
| AANSLUITINGEN                              | 34           |
| <b>MINI RADIATOREN</b>                     | <b>35</b>    |
| BESTEKTEKSTEN & TECHNISCHE TEKENINGEN      |              |
| MINI SUPER 6 UNIVERSEEL STANDAARD          | 36           |
| MINI SUPER 6 UNIVERSEEL KOMPAKT            | 38           |
| MINI SUPER 6 DESIGN 1                      | 40           |
| MINI SUPER 6 DESIGN 2                      | 42           |
| AANSLUITINGEN                              | 44           |
| Drukverliezen radiatoren en ventielinserts | 46           |
| CORRECTIETABEL                             | 47           |
| <b>WARMTEAFGIFTES PER TYPE RADIATOR</b>    |              |
| HORIZONTAAL                                | 50-85        |
| VERTICAAL                                  | 88-90        |
| MINI                                       | 94-97        |
| <b>KLEUREN</b>                             | <b>98-99</b> |

## PRODUCTIE

Superia radiatoren worden op de meest efficiënte wijze en met de modernste technieken geproduceerd. Superia radiatoren worden vervaardigd uit koudgewalst staal van hoge kwaliteit en elke radiator wordt individueel op dichtheid getest.

Superia radiatoren zijn geschikt voor alle centrale verwarmingsinstallaties met een maximum bedrijfstemperatuur van 110°C.

## KWALITEIT EN GARANTIE

Superia radiatoren voldoen aan alle kwaliteitseisen m.b.t. constructie, afwerking, lekdichtheid e.d. Superia garandeert haar producten op fabricage- en materiaalfouten voor de duur van 10 jaar na leverdatum, mits deskundig gemonteerd en gebruikt. Zie de algemene voorwaarden op [www.superia.be](http://www.superia.be) en [www.vasco-group.eu](http://www.vasco-group.eu).

## VERPAKKING

Alle Superia radiatoren worden stevig verpakt in hoogwaardig karton en geplastificeerd.

Deze verpakking is ontwikkeld om transportschade te voorkomen, het is aanbevolen om de verpakking tijdens de montage niet te verwijderen.

Eventuele beschadigingen, welke tijdens de montage ontstaan, dienen onmiddellijk te worden bijgewerkt. Hiervoor zijn op bestelling speciale lakstiften leverbaar.



## LAKAPPLICATIE

Superia radiatoren worden afgelakt in een zeer moderne speciaal ontworpen lakinstallatie, waarbij de belasting voor het milieu vrijwel tot nul is teruggebracht.

### VOORBEHANDELING:

Eerst worden de radiatoren gereinigd, ontvet en gefosfateerd.

Daarna worden ze gespoeld met gedemineraliseerd water om een optimale dekking te verkrijgen voor de speciale kataforese grondlak.

### GRONDLAK:

Hierna worden de radiatoren gemoffeld bij een temperatuur van 200°C.

### AFLAKKEN:

Vervolgens worden de radiatoren afgelakt met een epoxy-polyester laklaag in een volautomatische poedercoatinginstallatie en wederom gemoffeld bij 200°C.

Het resultaat is een zeer sterke en slagvaste afwerklaag, in de standaardkleur Superia wit.

### VOORDELEN:

- Optimale corrosiebestendigheid.
- Gelijkmatige laklaag met zeer goede dekking op kanten, hoeken en randen.
- Geen druppelvorming aan onderkanten.
- Grote kras- en stootvastheid.





# Horizontale RADIATOREN

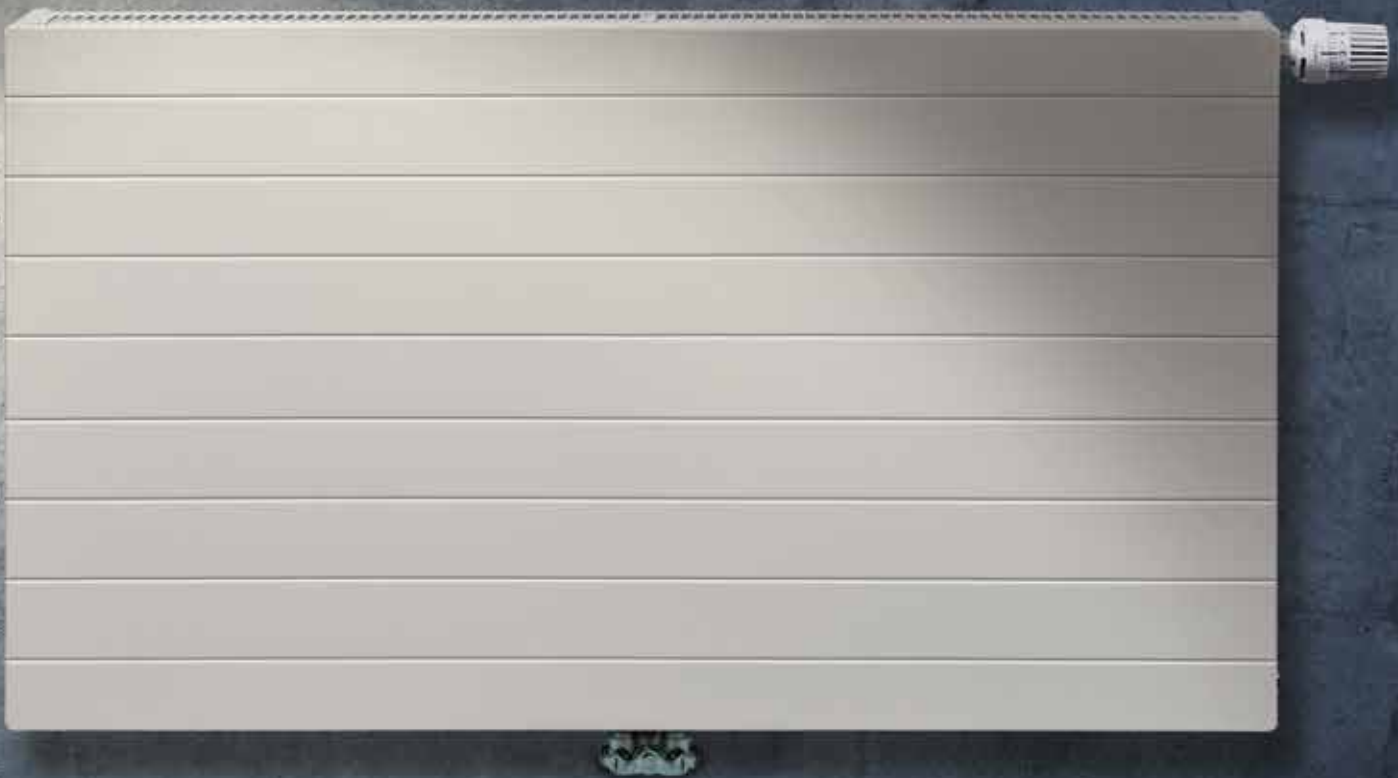

## STANDAARD

De Superia Standaard radiator is en blijft een klassieker. Toegespitst op een snelle warmteafgifte en een hoge verwarmingscapaciteit, ook in combinatie met lagetemperatuursystemen. Het assortiment telt maar liefst 6 uitvoeringen, van een radiator met 1 plaat, zonder convector, tot een superkrachtige radiator met 3 platen en 3 convectoren. En met alle gewenste of noodzakelijke toebehoren, want verwarmingscomfort moet ook praktisch zijn.

|                                  |  |
|----------------------------------|--|
| <b>Product:</b>                  | Paneelradiator met vier zijdelingse aansluitingen  |
| <b>Materiaal:</b>                | Staal  |
| <b>Afwerking:</b>                | Standaard  |
| <b>Meegelieferd:</b>             | L-beugels met vergrendeling en dempertjes, blindstop, ontluchter, schroeven en pluggen   |
| <b>Aansluitingen:</b>            | 4 x ½" binnendraad zijdelingse aansluitingen   |
| <b>Verpakking:</b>               | Iedere radiator wordt stevig verpakt in hoogwaardig karton en geplastificeerd. Een etiket beschrijft de radiatorkenmerken: type – hoogte – lengte. |
| <b>Garantie:</b>                 | 10 jaar, indien men de algemene voorwaarden van Superia respecteert.   |
| <b>Lakproces:</b>                | Alle radiatoren zijn ontvet, gefosfateerd, kataforetisch gegrondlakt en standaard in Superia wit gepoederlakt.                                     |
| <b>Kleur:</b>                    | Superia wit  |
| <b>Warmtetellers:</b>            | Zonder beperkingen geschikt voor warmtetellers, zowel elektrisch als volgens verdampingsprincipe (overeenkomstig EN834 835).                       |
| <b>Max. werkdruk:</b>            | 10 bar (getest op 13 bar)  |
| <b>Max. bedrijfstemperatuur:</b> | 110 °C   |
| <b>Conformiteit:</b>             | Volgens EN442-1: 2014: radiatoren en convectoren   |
| <b>Types:</b>                    | 10   11   21s   22   33  |
| <b>Hoogtes:</b>                  | 300   400   500   600   700   900 mm   |
| <b>Lengtes:</b>                  | 400 => 3000 mm   |
| <b>Dieptes:</b>                  | 61   73   106   165 mm   |

TYPE 10 / 11



TYPE 21s



TYPE 22



TYPE 33



# Casual

made by Brugman

TECHNISCHE GEGEVENS PER LOPENDE METER BIJ 75/65/20°C

| Hoogte (mm) |    | NEW     | NEW     | Type 21s | Type 22 | Type 33 |
|-------------|----|---------|---------|----------|---------|---------|
|             |    | Type 10 | Type 11 |          |         |         |
| 300         | W  |         | 551     |          | 975     | 1365    |
|             | kg |         | 6,92    |          | 13,49   | 20,19   |
|             | l  |         | 2,20    |          | 3,55    | 5,29    |
|             | n  |         | 1,22    |          | 1,28    | 1,31    |
| 400         | W  | 425     | 697     | 985      | 1241    | 1744    |
|             | kg | 7,07    | 9,20    | 15,95    | 18,05   | 27,02   |
|             | l  | 2,49    | 2,49    | 4,42     | 4,47    | 6,71    |
|             | n  | 1,26    | 1,24    | 1,31     | 1,30    | 1,31    |
| 500         | W  | 514     | 840     | 1181     | 1494    | 2103    |
|             | kg | 8,64    | 11,49   | 19,82    | 22,61   | 33,86   |
|             | l  | 2,82    | 2,82    | 5,33     | 5,38    | 8,07    |
|             | n  | 1,27    | 1,25    | 1,32     | 1,33    | 1,32    |
| 600         | W  | 602     | 979     | 1368     | 1738    | 2444    |
|             | kg | 10,21   | 13,77   | 23,68    | 27,17   | 40,70   |
|             | l  | 3,18    | 3,18    | 6,22     | 6,27    | 9,39    |
|             | n  | 1,29    | 1,27    | 1,32     | 1,34    | 1,32    |
| 700         | W  |         | 1117    |          | 1974    | 2769    |
|             | kg |         | 16,08   |          | 31,74   | 47,53   |
|             | l  |         | 3,56    |          | 7,14    | 10,65   |
|             | n  |         | 1,28    |          | 1,35    | 1,33    |
| 900         | W  | 872     | 1390    | 1880     | 2429    | 3376    |
|             | kg | 14,95   | 20,64   | 35,28    | 40,86   | 61,19   |
|             | l  | 4,42    | 4,42    | 8,77     | 8,84    | 13,02   |
|             | n  | 1,29    | 1,30    | 1,34     | 1,36    | 1,36    |

## TECHNISCHE TEKENINGEN STANDAARD

### L-BEUGELS

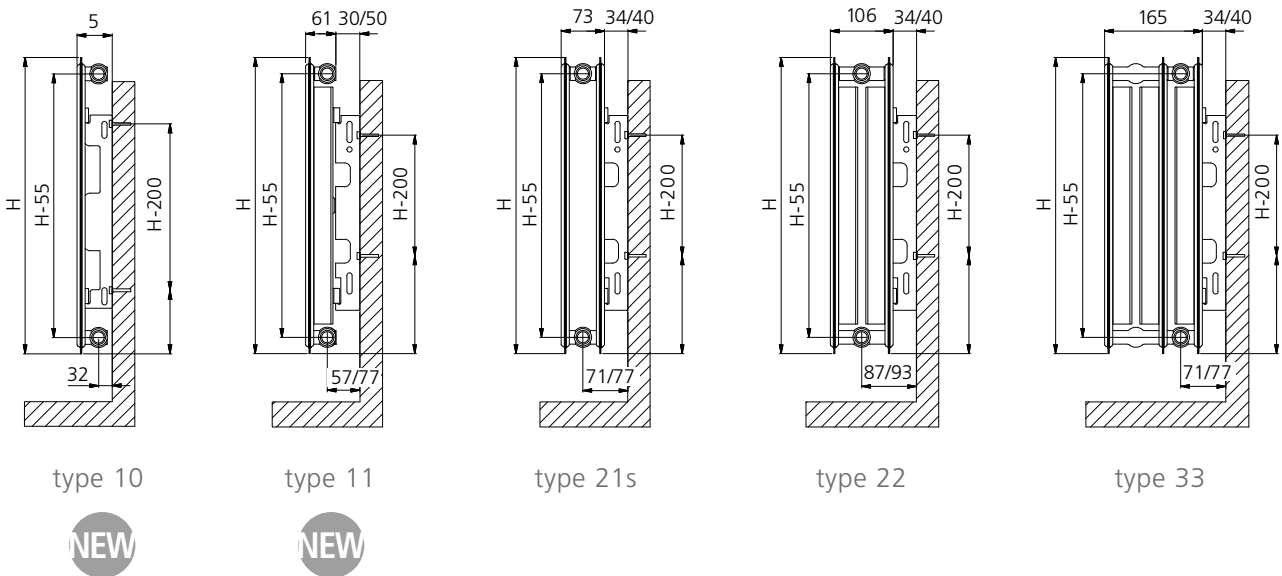

## KOMPAKT

De Superia Kompakt verenigt alle eigenschappen en voordelen van de Standaard radiator, maar dan in een compacte, stijlvolle vorm. Met zijn sierrooster bovenaan en zijn fraaie zijbekleding zorgt hij overal voor extra comfort en gezelligheid. En met z'n 4 aansluitingspunten kan hij overal probleemloos worden geïnstalleerd, met een optimaal verwarmingscomfort als resultaat. Net als de Standaard leverbaar met alle noodzakelijke of gewenste accessoires, zoals een praktische handdoekbeugel voor keuken en badkamer.

|                                  |  |
|----------------------------------|--|
| <b>Product:</b>                  | Paneelradiator met vier zijdelingse aansluitingen  |
| <b>Materiaal:</b>                | Staal  |
| <b>Afwerking:</b>                | Bovenrooster en zijbekledingen   |
| <b>Meegelieferd:</b>             | L-beugels met vergrendeling en dempertjes, blindstop, ontluchter, schroeven en pluggen   |
| <b>Aansluitingen:</b>            | 4 x ½" binnendraad zijdelingse aansluitingen   |
| <b>Verpakking:</b>               | Iedere radiator wordt stevig verpakt in hoogwaardig karton en geplastificeerd. Een etiket beschrijft de radiatorkenmerken: type – hoogte – lengte. |
| <b>Garantie:</b>                 | 10 jaar, indien men de algemene voorwaarden van Superia respecteert.   |
| <b>Lakproces:</b>                | Alle radiatoren zijn ontvet, gefosfateerd, kataforetisch gegrondlakt en standaard in Superia wit gepoederlakt.                                     |
| <b>Kleur:</b>                    | Superia wit  |
| <b>Warmteters:</b>               | Zonder beperkingen geschikt voor warmteters, zowel elektrisch als volgens verdampingsprincipe (overeenkomstig EN834 835).                          |
| <b>Max. werkdruk:</b>            | 10 bar (getest op 13 bar)  |
| <b>Max. bedrijfstemperatuur:</b> | 110 °C   |
| <b>Conformiteit:</b>             | Volgens EN442-1: 2014: radiatoren en convectoren   |
| <b>Types:</b>                    | 11   21s   22   33   |
| <b>Hoogtes:</b>                  | 300   400   500   600   700   900 mm   |
| <b>Lengtes:</b>                  | 400 => 3000 mm   |
| <b>Dieptes:</b>                  | 61   73   106   165 mm   |

TYPE 11



TYPE 21s



TYPE 22



TYPE 33



# Casual

TECHNISCHE GEGEVENS PER LOPENDE METER BIJ 75/65/20°C

|             |    | <b>NEW</b> |          |         |         |
|-------------|----|------------|----------|---------|---------|
| Hoogte (mm) |    | Type 11    | Type 21s | Type 22 | Type 33 |
| 300         | W  |            |          | 942     | 1319    |
|             | kg |            |          | 14,72   | 21,93   |
|             | l  |            |          | 3,55    | 5,29    |
|             | n  |            |          | 1,31    | 1,32    |
| 400         | W  | 697        | 953      | 1202    | 1679    |
|             | kg | 10,66      | 16,82    | 19,47   | 29,04   |
|             | l  | 2,49       | 4,42     | 4,47    | 6,71    |
|             | n  | 1,24       | 1,31     | 1,32    | 1,32    |
| 500         | W  | 840        | 1141     | 1449    | 2020    |
|             | kg | 13,13      | 20,82    | 24,21   | 36,14   |
|             | l  | 2,82       | 5,33     | 5,38    | 8,07    |
|             | n  | 1,25       | 1,32     | 1,32    | 1,32    |
| 600         | W  | 979        | 1322     | 1683    | 2345    |
|             | kg | 15,61      | 24,81    | 28,96   | 43,25   |
|             | l  | 3,18       | 6,22     | 6,27    | 9,39    |
|             | n  | 1,27       | 1,32     | 1,33    | 1,32    |
| 700         | W  | 1117       | 1499     | 1907    | 2657    |
|             | kg | 18,11      | 28,82    | 33,73   | 50,35   |
|             | l  | 3,57       | 7,09     | 7,14    | 10,65   |
|             | n  | 1,28       | 1,32     | 1,33    | 1,33    |
| 900         | W  | 1390       | 1841     | 2326    | 3248    |
|             | kg | 23,03      | 36,77    | 43,18   | 64,52   |
|             | l  | 4,42       | 8,77     | 8,84    | 13,02   |
|             | n  | 1,30       | 1,33     | 1,34    | 1,36    |

## TECHNISCHE TEKENINGEN KOMPAKT

### L-BEUGELS

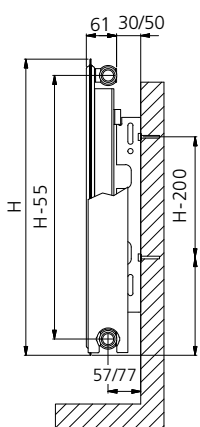

type 11

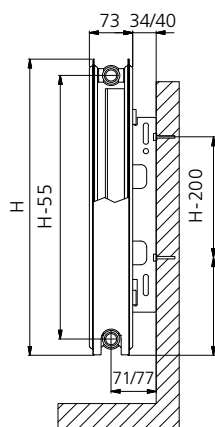

type 21s

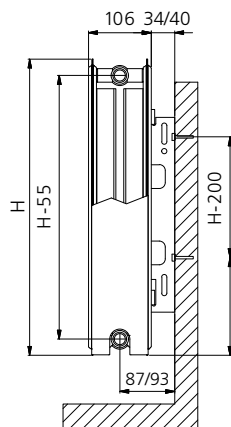

type 22

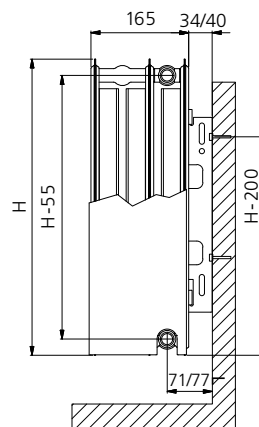

type 33

**NEW**

## SUPER 6 UNIVERSEEL

De Superia Super 6 Universeel radiator doet zijn naam alle eer aan, want hij is super in alle opzichten. Supercomfortabel, door zijn snelle, gecontroleerde warmteafgifte. Superflexibel dankzij de 6 verschillende aansluitingen. En supermooi afgewerkt, want standaard geleverd met een fraai sierrooster en een dito zijbekleding. Een radiator die zich thuisvoelt in elke woon- en werkruimte en die zich gewillig plooit naar uw comfortwensen en behoeften. Een passende handdoekbeugel in optie, maakt dit type radiator nog passender.

|                                  |  |
|----------------------------------|--|
| <b>Product:</b>                  | Ventielradiator met zowel een rechteronderaansluiting als vier zijdelingse aansluitingen. Door het gebruik van de J-console is het mogelijk de radiator te spiegelen zodat de thermostaatknop links of rechts kan gemonteerd worden (m.u.v. type 11).                        |
| <b>Materiaal:</b>                | Staal  |
| <b>Afwerking:</b>                | Bovenrooster en zijbekledingen   |
| <b>Ventiel:</b>                  | Het meegeleverde ventielinsert (zonder thermostatische kraan) is compatibel met thermostatische kranen M30 x 1,5 mm.   |
| <b>Meegeleverd:</b>              | L-beugels (type 11) met vergrendeling en dempertjes, blindstoppen, ontluchter en ventielinsert, schroeven en pluggen<br>J-beugels (type 20s/21s/22/33), blindstoppen, ontluchter en ventielinsert, schroeven en pluggen<br>Optie: Haakje voor montage J-beugel onder rooster |
| <b>Aansluitingen:</b>            | 2 x ¾" buitendraadse euroconus rechteronderaansluiting,<br>4 x ½" binnendraad zijdelingse aansluitingen  |
| <b>Verpakking:</b>               | Iedere radiator wordt stevig verpakt in hoogwaardig karton en geplastificeerd. Een etiket beschrijft de radiatorkenmerken: type – hoogte – lengte.   |
| <b>Garantie:</b>                 | 10 jaar, indien men de algemene voorwaarden van Superia respecteert.   |
| <b>Lakproces:</b>                | Alle radiatoren zijn ontvet, gefosfateerd, kataforetisch gegrondlakt en standaard in Superia wit gepoederlakt.   |
| <b>Kleur:</b>                    | Superia wit  |
| <b>Warmteters:</b>               | Zonder beperkingen geschikt voor warmteters, zowel elektrisch als volgens verdampingsprincipe (overeenkomstig EN834 835).  |
| <b>Max. werkdruk:</b>            | 10 bar (getest op 13 bar)  |
| <b>Max. bedrijfstemperatuur:</b> | 110 °C   |
| <b>Conformiteit:</b>             | Volgens EN442-1: 2014: radiatoren en convectoren   |
| <b>Types:</b>                    | 11   20s   21s   22   33   |
| <b>Hoogtes:</b>                  | 300   400   500   600   700   900 mm   |
| <b>Lengtes:</b>                  | 400 => 3000 mm   |
| <b>Dieptes:</b>                  | 61   73   106   165 mm   |

TYPE 11



TYPE 20s/21s



TYPE 22



TYPE 33



# Casual

TECHNISCHE GEGEVENS PER LOPENDE METER BIJ 75/65/20°C

|             |    | <b>NEW</b> |          |          |         |         |
|-------------|----|------------|----------|----------|---------|---------|
| Hoogte (mm) |    | Type 11    | Type 20s | Type 21s | Type 22 | Type 33 |
| 300         | W  |            |          |          | 942     | 1334    |
|             | kg |            |          |          | 14,96   | 22,19   |
|             | l  |            |          |          | 3,55    | 5,29    |
|             | n  |            |          |          | 1,31    | 1,29    |
| 400         | W  | 697        | 740      | 953      | 1202    | 1700    |
|             | kg | 10,83      | 15,00    | 17,13    | 19,75   | 29,35   |
|             | l  | 2,49       | 4,42     | 4,42     | 4,47    | 6,71    |
|             | n  | 1,24       | 1,29     | 1,31     | 1,32    | 1,30    |
| 500         | W  | 840        | 884      | 1141     | 1449    | 2048    |
|             | kg | 13,36      | 18,33    | 21,18    | 24,55   | 36,50   |
|             | l  | 2,82       | 5,33     | 5,33     | 5,38    | 8,07    |
|             | n  | 1,25       | 1,30     | 1,32     | 1,32    | 1,31    |
| 600         | W  | 979        | 1026     | 1322     | 1683    | 2379    |
|             | kg | 15,89      | 21,66    | 25,22    | 29,35   | 47,81   |
|             | l  | 3,18       | 6,22     | 6,22     | 6,27    | 9,39    |
|             | n  | 1,27       | 1,30     | 1,32     | 1,33    | 1,32    |
| 700         | W  | 1117       | 1166     | 1499     | 1907    | 2696    |
|             | kg | 18,44      | 25,01    | 29,29    | 34,17   | 50,82   |
|             | l  | 3,57       | 7,09     | 7,09     | 7,14    | 10,65   |
|             | n  | 1,28       | 1,31     | 1,32     | 1,33    | 1,33    |
| 900         | W  | 1390       | 1446     | 1841     | 2326    | 3297    |
|             | kg | 23,49      | 31,68    | 37,37    | 43,76   | 65,12   |
|             | l  | 4,42       | 8,77     | 8,77     | 8,84    | 13,02   |
|             | n  | 1,30       | 1,32     | 1,33     | 1,34    | 1,34    |

## TECHNISCHE TEKENINGEN SUPER 6 UNIVERSEEL

### L-BEUGELS

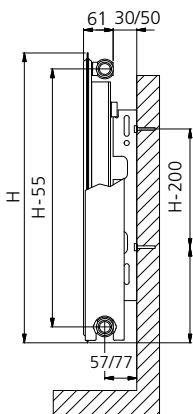

type 11

**NEW**

### J-BEUGELS

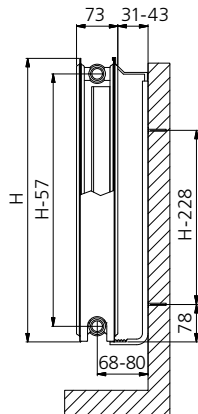

type 20s

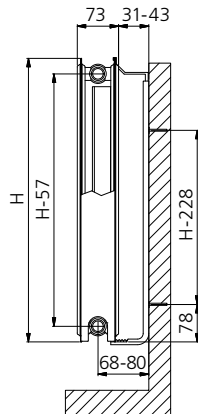

type 21s

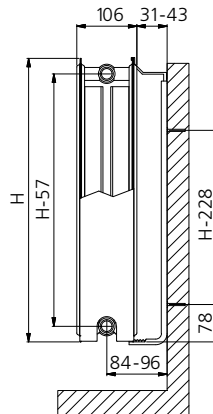

type 22

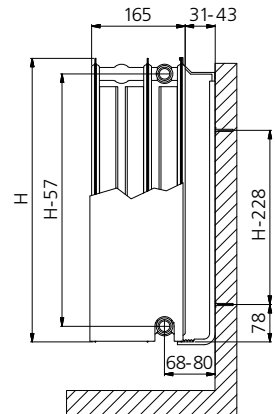

type 33

## SUPER 6 DESIGN

De Superia Super 6 Design radiator komt met zijn vlakke voorplaat en afgeronde hoeken in elk interieur perfect tot zijn recht. Bovendien is de Super 6 Design ook uiterst onderhoudsvriendelijk. Zelfs de voorplaat is eenvoudig te vervangen door het praktische kliksysteem.

|                                  |   |
|----------------------------------|---|
| <b>Product:</b>                  | Ventielradiator met zowel een rechteronderaansluiting als vier zijdelingse aansluitingen met meegeleverde ventielinsert. Door het gebruik van de J-console is het mogelijk de radiator te spiegelen zodat de thermostaatknop links of rechts kan gemonteerd worden.<br>De radiator is bekleed met een vlakke voorplaat. |
| <b>Materiaal:</b>                | Staal   |
| <b>Afwerking:</b>                | Bovenrooster, zijbekledingen en vlakke voorplaat  |
| <b>Ventiel:</b>                  | Het meegeleverde ventielinsert (zonder thermostatische kraan) is compatibel met thermostatische kranen M30 x 1,5 mm.  |
| <b>Meegeleverd:</b>              | J-beugels, blindstoppen, ontluchter, ventielinsert, schroeven en pluggen<br>Optie: Haakje voor montage J-beugel onder rooster   |
| <b>Aansluitingen:</b>            | 2 x $\frac{3}{4}$ " buitendraadse euroconus rechteronderaansluiting,<br>4 x $\frac{1}{2}$ " binnendraad zijdelingse aansluitingen   |
| <b>Verpakking:</b>               | Iedere radiator wordt stevig verpakt in hoogwaardig karton en geplastificeerd.<br>Een etiket beschrijft de radiator karakteristieken: type – hoogte – lengte.   |
| <b>Garantie:</b>                 | 10 jaar, indien men de algemene voorwaarden van Superia respecteert.  |
| <b>Lakproces:</b>                | Alle radiatoren zijn ontvet, gefosfateerd, kataforetisch gegrondlakt en standaard in Superia wit gepoederlakt.  |
| <b>Kleur:</b>                    | Superia wit   |
| <b>Max. werkdruk:</b>            | 10 bar (getest op 13 bar)   |
| <b>Max. bedrijfstemperatuur:</b> | 110 °C  |
| <b>Conformiteit:</b>             | Volgens EN442-1: 2014: radiatoren en convectoren  |
| <b>Types:</b>                    | 21s   22   33   |
| <b>Hoogtes:</b>                  | 300   400   500   600   700   900 mm  |
| <b>Lengtes:</b>                  | 400 => 3000 mm  |
| <b>Dieptes:</b>                  | 74,5   107,5   166,5 mm   |

TYPE 21s



TYPE 22



TYPE 33





# Casual

TECHNISCHE GEGEVENS PER LOPENDE METER BIJ 75/65/20°C

| Hoogte (mm) |    | Type 21s | Type 22 | Type 33 |
|-------------|----|----------|---------|---------|
| 300         | W  |          | 878     | 1236    |
|             | kg |          | 16,96   | 24,17   |
|             | l  |          | 3,55    | 5,29    |
|             | n  |          | 1,30    | 1,32    |
| 400         | W  | 868      | 1104    | 1532    |
|             | kg | 19,78    | 22,42   | 31,99   |
|             | l  | 4,42     | 4,47    | 6,71    |
|             | n  | 1,29     | 1,30    | 1,32    |
| 500         | W  | 1034     | 1317    | 1822    |
|             | kg | 24,50    | 27,90   | 39,82   |
|             | l  | 5,33     | 5,38    | 8,07    |
|             | n  | 1,29     | 1,31    | 1,32    |
| 600         | W  | 1192     | 1521    | 2110    |
|             | kg | 29,20    | 33,35   | 47,64   |
|             | l  | 6,22     | 6,27    | 9,39    |
|             | n  | 1,30     | 1,31    | 1,32    |
| 700         | W  | 1342     | 1717    | 2399    |
|             | kg | 33,98    | 38,89   | 55,52   |
|             | l  | 7,09     | 7,14    | 10,65   |
|             | n  | 1,30     | 1,30    | 1,32    |
| 900         | W  | 1623     | 2089    | 2991    |
|             | kg | 43,30    | 49,71   | 71,05   |
|             | l  | 8,77     | 8,84    | 13,02   |
|             | n  | 1,29     | 1,28    | 1,32    |

## TECHNISCHE TEKENINGEN SUPER 6 DESIGN

### J-BEUGELS

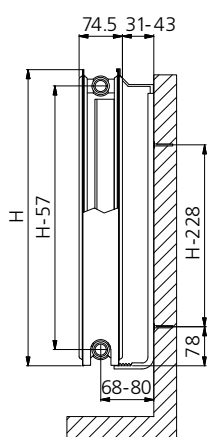

type 21s

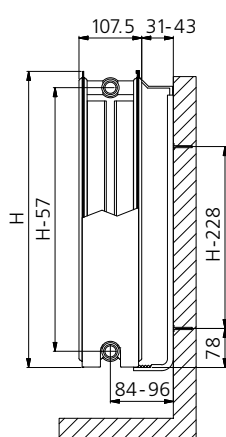

type 22

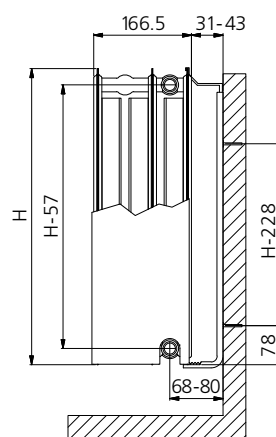

type 33

## CENTRAL (GALVA)

De Superia Central ventielradiator combineert een superieure warmtevoorziening met een toekomstgerichte technologie en een stijlvolle uitstraling. Door zijn mix van eenvoud, efficiëntie en esthetiek, nog versterkt door de slimme, vaste **middenaansluiting**, vormt de ventielradiator een harmonisch geheel in elke woon-en werkkruimte.

|                                  |   |
|----------------------------------|---|
| <b>Product:</b>                  | Ventielradiator met zowel een middenaansluiting (onder) als vier zijdelingse aansluitingen met meegeleverd ventielinsert. Door het gebruik van de J-console is het mogelijk de radiator te spiegelen zodat de thermostaatknop links of rechts kan gemonteerd worden (m.u.v. type 11). |
| <b>Materiaal:</b>                | Staal   |
| <b>Afwerking:</b>                | Bovenrooster en zijbekledingen  |
| <b>Ventiel:</b>                  | Het meegeleverde ventielinsert (zonder thermostatische kraan) is compatibel met thermostatische kranen M30 x 1,5 mm.  |
| <b>Meegeleverd:</b>              | L-beugels (type 11) met vergrendeling en dempertjes, blindstoppen en ontluchter, ventielinsert, schroeven en pluggen<br>J-beugels (type 21s/22/33), blindstoppen, ontluchter, ventielinsert, schroeven en pluggen<br>Optie: Haakje voor montage J-beugel onder rooster                |
| <b>Aansluitingen:</b>            | 2 x ¾" buitendraadse euroconus 50 mm middenaansluiting (onder),<br>4 x ½" binnendraad zijdelingse aansluitingen   |
| <b>Verpakking:</b>               | Iedere radiator wordt stevig verpakt in hoogwaardig karton en geplastificeerd. Een etiket beschrijft de radiator karakteristieken: type – hoogte – lengte.  |
| <b>Garantie:</b>                 | 10 jaar, indien men de algemene voorwaarden van Superia respecteert.  |
| <b>Lakproces:</b>                | Alle radiatoren zijn ontvet, gefosfateerd, kataforetisch gegrondlakt en standaard in Superia wit gepoederlakt.<br>Central Galva is eerst voorzien van een beschermende gegalvaniseerde onderlaag (dan gevolgd door de bovenstaande stappen).  |
| <b>Kleur:</b>                    | Superia wit   |
| <b>Warmtetellers:</b>            | Zonder beperkingen geschikt voor warmtetellers, zowel elektrisch als volgens verdampingsprincipe (overeenkomstig EN834 835).  |
| <b>Max. werkdruk:</b>            | 10 bar (getest op 13 bar)   |
| <b>Max. bedrijfstemperatuur:</b> | 110 °C  |
| <b>Conformiteit:</b>             | Volgens EN442-1: 2014: radiatoren en convectoren  |
| <b>Types:</b>                    | 11   21s   22   33  |
| <b>Hoogtes:</b>                  | 300   400   500   600   700   900 mm  |
| <b>Lengtes:</b>                  | 400 => 3000 mm  |
| <b>Dieptes:</b>                  | 61   73   106   165 mm  |

TYPE 11



TYPE 21s



TYPE 22



TYPE 33



# Central

## ONDERAANZICHT Montage rechts

TECHNISCHE GEGEVENS PER LOPENDE METER BIJ 75/65/20°C

| Hoogte (mm) |    | NEW     |          |         |         |
|-------------|----|---------|----------|---------|---------|
|             |    | Type 11 | Type 21s | Type 22 | Type 33 |
| 300         | W  |         | 755      | 942     | 1334    |
|             | kg |         | 13,92    | 15,65   | 22,87   |
|             | l  |         | 3,50     | 3,55    | 5,29    |
|             | n  |         | 1,31     | 1,31    | 1,29    |
| 400         | W  | 697     | 953      | 1202    | 1700    |
|             | kg | 11,53   | 18,00    | 20,49   | 30,03   |
|             | l  | 2,49    | 4,42     | 4,47    | 6,71    |
|             | n  | 1,24    | 1,31     | 1,32    | 1,30    |
| 500         | W  | 840     | 1141     | 1449    | 2048    |
|             | kg | 14,05   | 22,09    | 25,20   | 37,22   |
|             | l  | 2,82    | 5,33     | 5,38    | 8,07    |
|             | n  | 1,25    | 1,32     | 1,32    | 1,31    |
| 600         | W  | 979     | 1322     | 1683    | 2379    |
|             | kg | 16,60   | 26,14    | 30,04   | 44,43   |
|             | l  | 3,18    | 6,22     | 6,27    | 9,39    |
|             | n  | 1,27    | 1,32     | 1,33    | 1,32    |
| 700         | W  | 1117    | 1499     | 1907    | 2696    |
|             | kg | 19,16   | 29,59    | 34,24   | 50,97   |
|             | l  | 3,57    | 7,09     | 7,14    | 10,65   |
|             | n  | 1,28    | 1,32     | 1,33    | 1,33    |
| 900         | W  | 1390    | 1841     | 2326    | 3297    |
|             | kg | 24,23   | 38,06    | 44,50   | 65,95   |
|             | l  | 4,42    | 8,77     | 8,84    | 13,02   |
|             | n  | 1,30    | 1,33     | 1,34    | 1,34    |

NEW

Type 11

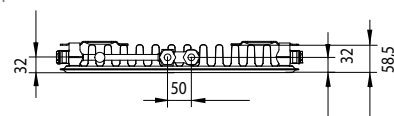

Type 21s

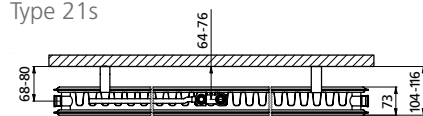

Type 22

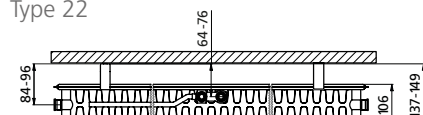

Type 33

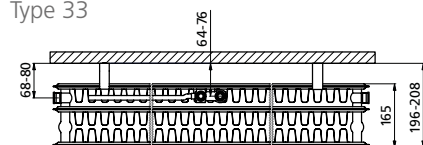

## Montage links

Type 21s

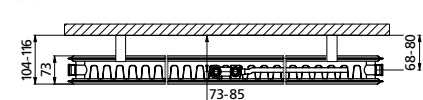

Type 22

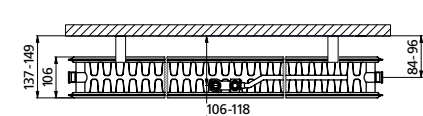

Type 33

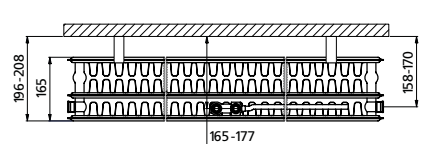

## TECHNISCHE TEKENINGEN CENTRAL (GALVA)

### L-BEUGELS

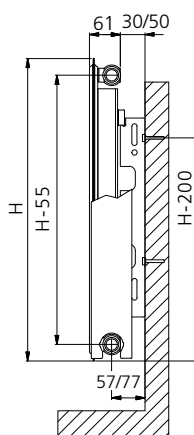

type 11

NEW

### J-BEUGELS

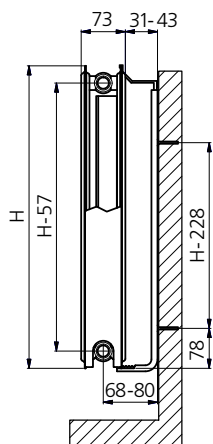

type 21s

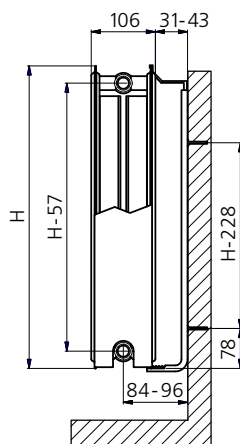

type 22

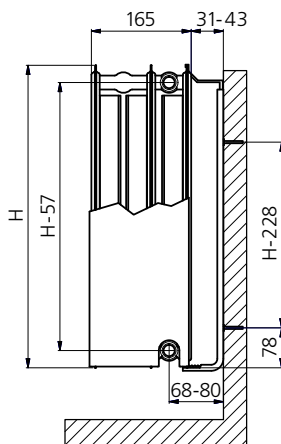

type 33

## CENTRAL DESIGN

De Superia Central Design ventielradiator combineert een superieure warmtevoorziening met een toekomstgerichte technologie en een stijlvolle uitstraling met zijn vlakke voorplaat en afgeronde hoeken. Door zijn mix van eenvoud, efficiëntie en esthetiek, nog versterkt door de slimme, vaste **middenaansluiting**, vormt de ventielradiator een harmonisch geheel in elke woon- en werkruimte. Met een onzichtbare muurbevestiging is het resultaat nog evenwichtiger. Bovendien is de Central Design ook uiterst onderhoudsvriendelijk. Zelfs de voorplaat is eenvoudig te vervangen door het praktische kliksysteem.

|                                  |   |
|----------------------------------|---|
| <b>Product:</b>                  | Ventielradiator met zowel een middenaansluiting (onder) als vier zijdelingse aansluitingen met meegeleverd ventielinsert.<br>De radiator is bekleed met een vlakke voorplaat. |
| <b>Materiaal:</b>                | Staal   |
| <b>Afwerking:</b>                | Bovenrooster, zijbekledingen en vlakke voorplaat  |
| <b>Ventiel:</b>                  | Het meegeleverde ventielinsert (zonder thermostatische kraan) is compatibel met thermostatische kranen M30 x 1,5 mm.  |
| <b>Meegeleverd:</b>              | J-beugels, blindstoppen, ontluchter, ventielinsert, schroeven en pluggen<br>Optie: Haakje voor montage J-beugel onder rooster   |
| <b>Aansluitingen:</b>            | 2 x ¾" buitendraadse euroconus 50 mm middenaansluiting (onder),<br>4 x ½" binnendraad zijdelingse aansluitingen   |
| <b>Verpakking:</b>               | Iedere radiator wordt stevig verpakt in hoogwaardig karton en geplastificeerd.<br>Een etiket beschrijft de radiator karakteristieken: type – hoogte – lengte.                 |
| <b>Garantie:</b>                 | 10 jaar, indien men de algemene voorwaarden van Superia respecteert.  |
| <b>Lakproces:</b>                | Alle radiatoren zijn ontvet, gefosfateerd, kataforetisch gegrondlakt en standaard in Superia wit gepoederlakt.  |
| <b>Kleur:</b>                    | Superia wit   |
| <b>Max. werkdruk:</b>            | 10 bar (getest op 13 bar)   |
| <b>Max. bedrijfstemperatuur:</b> | 110 °C  |
| <b>Conformiteit:</b>             | Volgens EN442-1: 2014: radiatoren en convectoren  |
| <b>Types:</b>                    | 21s   22   33   |
| <b>Hoogtes:</b>                  | 300   400   500   600   700   900 mm  |
| <b>Lengtes:</b>                  | 400 => 3000 mm  |
| <b>Dieptes:</b>                  | 74,5   107,5   166,5 mm   |

TYPE 21s



TYPE 22



TYPE 33



# Central

TECHNISCHE GEGEVENS PER LOPENDE METER BIJ 75/65/20°C

| Hoogte (mm) |    | Type 21s | Type 22 | Type 33 |
|-------------|----|----------|---------|---------|
| 300         | W  | 690      | 878     | 1236    |
|             | kg | 16,15    | 17,89   | 25,11   |
|             | l  | 3,50     | 3,55    | 5,29    |
|             | n  | 1,28     | 1,30    | 1,32    |
| 400         | W  | 868      | 1104    | 1532    |
|             | kg | 20,96    | 23,45   | 32,99   |
|             | l  | 4,42     | 4,47    | 6,71    |
|             | n  | 1,29     | 1,30    | 1,32    |
| 500         | W  | 1034     | 1317    | 1822    |
|             | kg | 25,77    | 28,88   | 40,91   |
|             | l  | 5,33     | 5,38    | 8,07    |
|             | n  | 1,29     | 1,31    | 1,32    |
| 600         | W  | 1192     | 1521    | 2110    |
|             | kg | 30,53    | 34,43   | 48,81   |
|             | l  | 6,22     | 6,27    | 9,39    |
|             | n  | 1,30     | 1,31    | 1,32    |
| 700         | W  | 1342     | 1717    | 2399    |
|             | kg | 34,75    | 39,40   | 56,14   |
|             | l  | 7,09     | 7,14    | 10,65   |
|             | n  | 1,30     | 1,30    | 1,32    |
| 900         | W  | 1623     | 2089    | 2991    |
|             | kg | 44,59    | 51,03   | 72,48   |
|             | l  | 8,77     | 8,84    | 13,02   |
|             | n  | 1,29     | 1,28    | 1,32    |

## ONDERAANZICHT

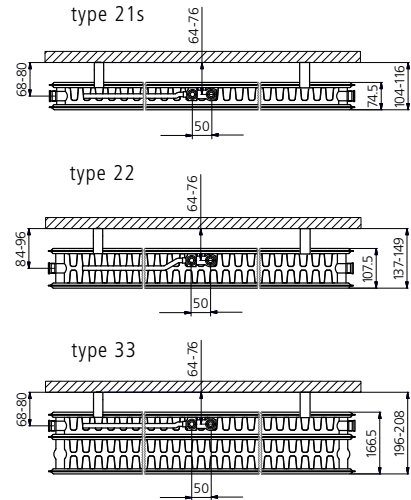

## TECHNISCHE TEKENINGEN CENTRAL DESIGN

### J-BEUGELS

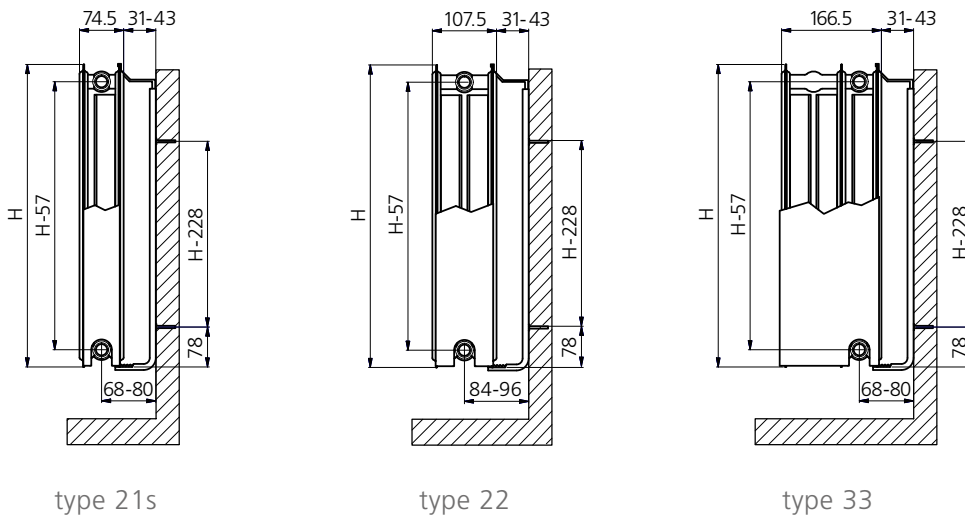

## CENTRAL LINE

De Superia Central Line ventielradiator combineert vormgeving en efficiëntie op z'n eenvoudigst en z'n puurst. De Central Line zorgt met de vlakke voorplaat met horizontale lijnen voor een strakke vormgeving in elk interieur. Eenvoudig, efficiënt en elegant... een klasse apart, gemaakt om te presteren en te charmeren. Met een onzichtbare muurbevestiging is het resultaat nog evenwichtiger.

Bovendien is de Central Line ook uiterst onderhoudsvriendelijk. Zelfs de voorplaat is eenvoudig te vervangen door het praktische kliksysteem.

|                                  |  |
|----------------------------------|--|
| <b>Product:</b>                  | Ventielradiator met zowel een middenaansluiting (onder) als vier zijdelingse aansluitingen met meegeleverd ventielinsert.<br>De radiator is bekleed met een vlakke voorplaat met horizontale lijnen. |
| <b>Materiaal:</b>                | Staal  |
| <b>Afwerking:</b>                | Bovenrooster, zijbekledingen en vlakke voorplaat met horizontale lijnen  |
| <b>Ventiel:</b>                  | Het meegeleverde ventielinsert (zonder thermostatische kraan) is compatibel met thermostatische kranen M30 x 1,5 mm.   |
| <b>Meegeleverd:</b>              | J-beugels, blindstoppen, ontluchter, ventielinsert, schroeven en pluggen<br>Optie: Haakje voor montage J-beugel onder rooster  |
| <b>Aansluitingen:</b>            | 2 x $\frac{3}{4}$ " buitendraadse euroconus 50 mm middenaansluiting (onder),<br>4 x $\frac{1}{2}$ " binnendraad zijdelingse aansluitingen  |
| <b>Verpakking:</b>               | Iedere radiator wordt stevig verpakt in hoogwaardig karton en geplastificeerd.<br>Een etiket beschrijft de radiator karakteristieken: type – hoogte – lengte.  |
| <b>Garantie:</b>                 | 10 jaar, indien men de algemene voorwaarden van Superia respecteert.   |
| <b>Lakproces:</b>                | Alle radiatoren zijn ontvet, gefosfateerd, kataforetisch gegrondlakt en standaard in Superia wit gepoederlakt.   |
| <b>Kleur:</b>                    | Superia wit  |
| <b>Max. werkdruk:</b>            | 10 bar (getest op 13 bar)  |
| <b>Max. bedrijfstemperatuur:</b> | 110 °C   |
| <b>Conformiteit:</b>             | Volgens EN442-1: 2014: radiatoren en convectoren   |
| <b>Types:</b>                    | 21s   22   33  |
| <b>Hoogtes:</b>                  | 300   400   500   600   700   900 mm   |
| <b>Lengtes:</b>                  | 400 => 3000 mm   |
| <b>Dieptes:</b>                  | 74,5   107,5   166,5 mm  |

TYPE 21s



TYPE 22



TYPE 33



# Central

TECHNISCHE GEGEVENS PER LOPENDE METER BIJ 75/65/20°C

| Hoogte (mm) |    | Type 21s | Type 22 | Type 33 |
|-------------|----|----------|---------|---------|
| 300         | W  | 690      | 878     | 1236    |
|             | kg | 16,15    | 17,89   | 25,11   |
|             | l  | 3,50     | 3,55    | 5,29    |
|             | n  | 1,28     | 1,30    | 1,32    |
| 400         | W  | 868      | 1104    | 1532    |
|             | kg | 20,96    | 23,45   | 32,99   |
|             | l  | 4,42     | 4,47    | 6,71    |
|             | n  | 1,29     | 1,30    | 1,32    |
| 500         | W  | 1034     | 1317    | 1822    |
|             | kg | 25,77    | 28,88   | 40,91   |
|             | l  | 5,33     | 5,38    | 8,07    |
|             | n  | 1,29     | 1,31    | 1,32    |
| 600         | W  | 1192     | 1521    | 2110    |
|             | kg | 30,53    | 34,43   | 48,81   |
|             | l  | 6,22     | 6,27    | 9,39    |
|             | n  | 1,30     | 1,31    | 1,32    |
| 700         | W  | 1342     | 1717    | 2399    |
|             | kg | 34,75    | 39,40   | 56,14   |
|             | l  | 7,09     | 7,14    | 10,65   |
|             | n  | 1,30     | 1,30    | 1,32    |
| 900         | W  | 1623     | 2089    | 2991    |
|             | kg | 44,59    | 51,03   | 72,48   |
|             | l  | 8,77     | 8,84    | 13,02   |
|             | n  | 1,29     | 1,28    | 1,32    |

## ONDERAANZICHT

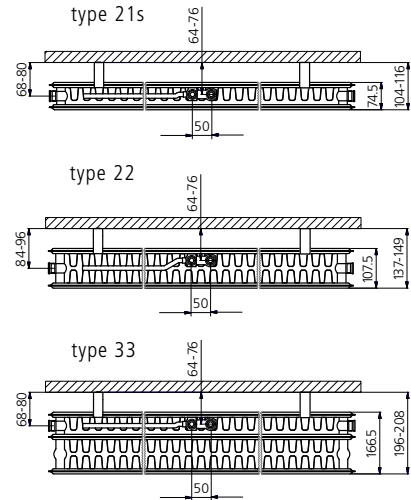

## TECHNISCHE TEKENINGEN CENTRAL LINE

### J-BEUGELS

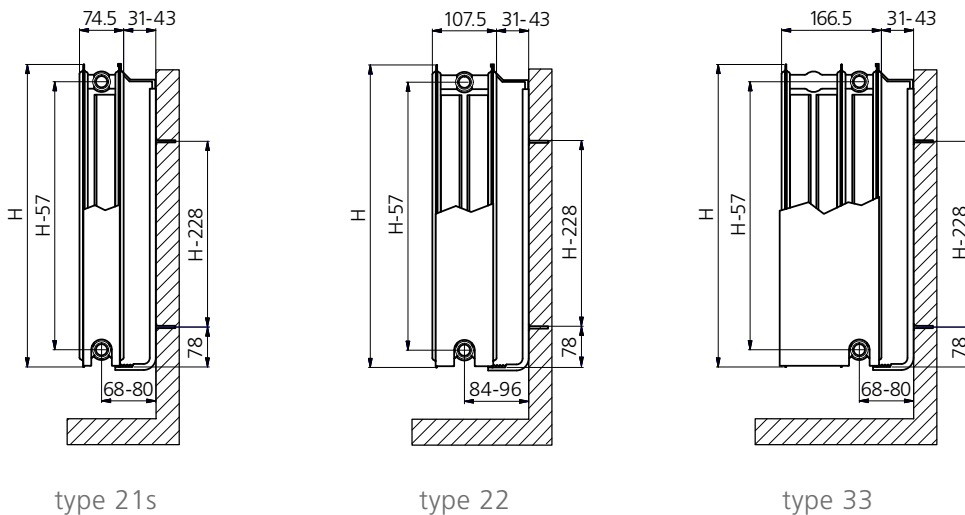

STANDAARD & KOMPAKT

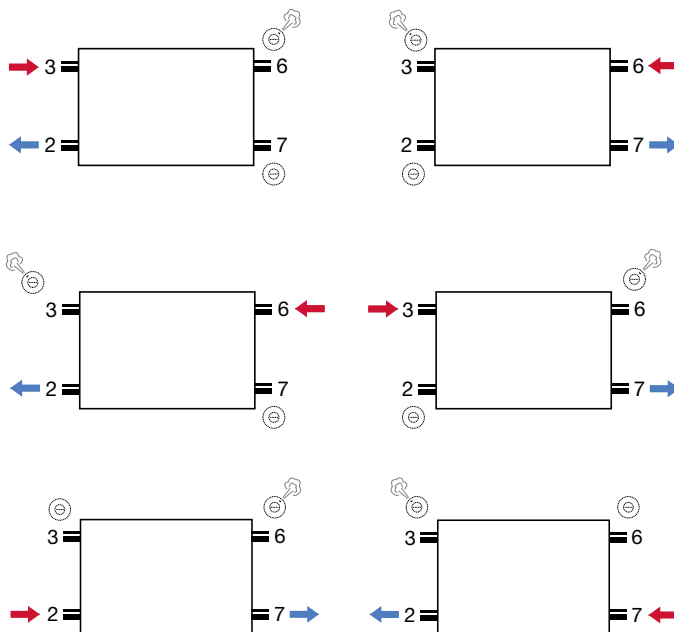

SUPER 6 UNIVERSEEL & SUPER 6 DESIGN

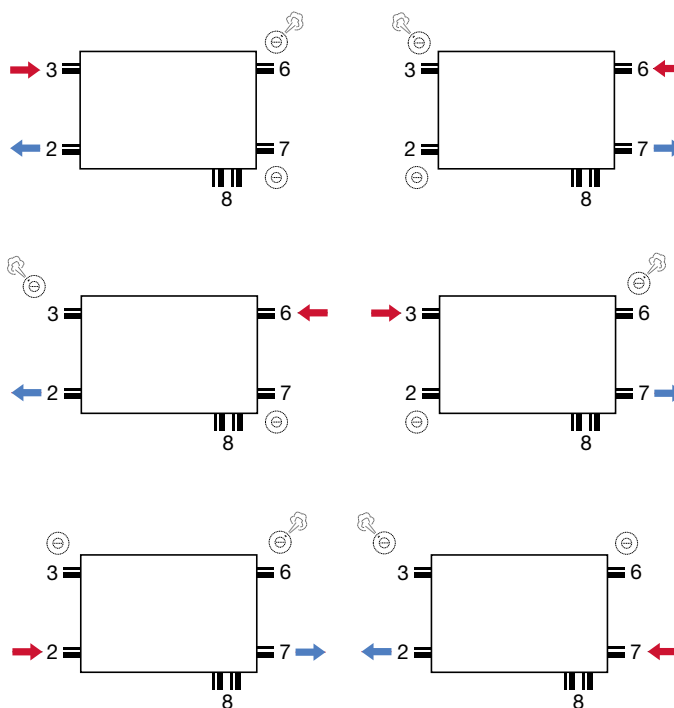
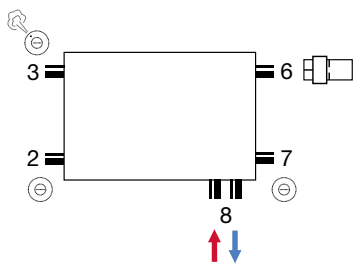

VENTIELAANSLUITING

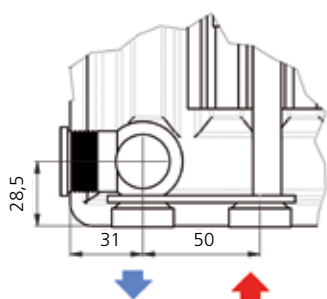

**Linkse versie ventiel aansluiting:**  
 door draaien van de radiator. Enkel mogelijk bij de Super 6 Universeel (met uitzondering van type 11).  
**Opgelet bij type 33:**  
 aansluiting tot de wand vergroot



## CENTRAL (GALVA) - CENTRAL DESIGN - CENTRAL LINE

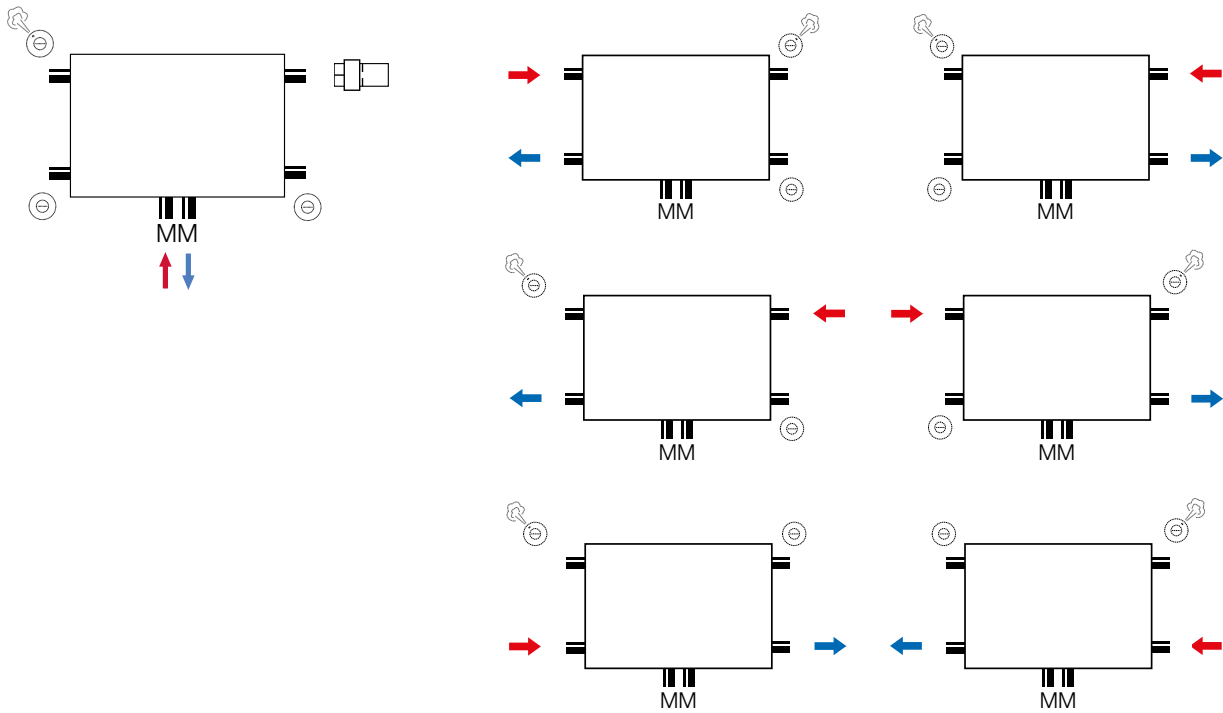

**Linkse versie ventilaansluiting:**

door draaien van de radiator. Enkel mogelijk bij de Central (met uitzondering van type 11).

**Opgelet bij type 33:**

aansluiting tot de wand vergroot

STANDAARD

KOMPAKT

SUPER 6 UNIVERSEEL type 11

CENTRAL (GALVA) type 11



**STRIPPENPLAN HORIZONTALE RADIATOREN**

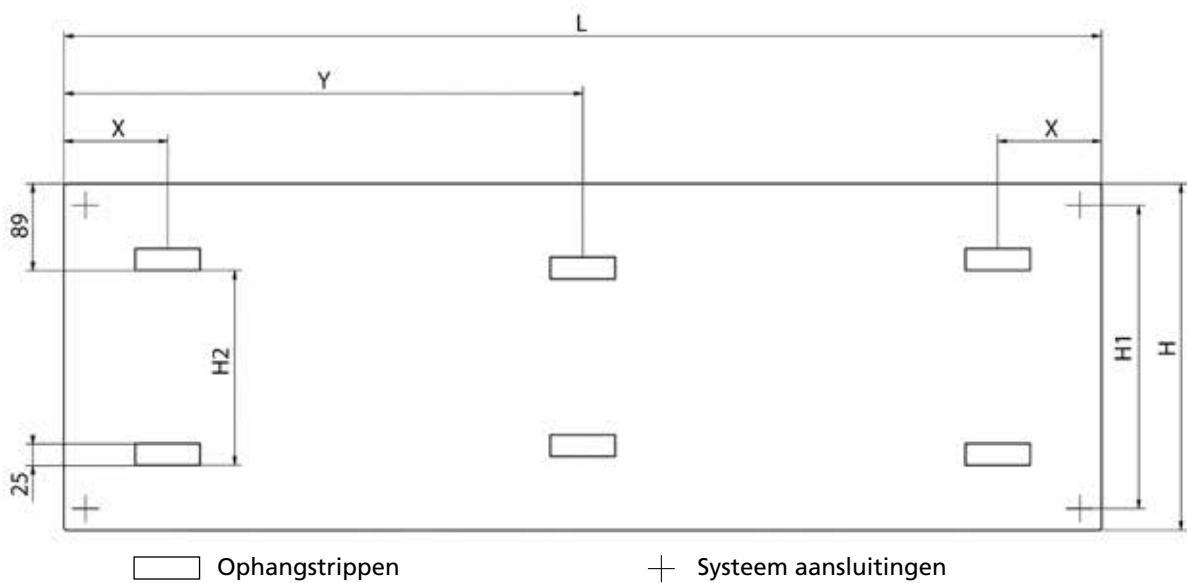

| POSITIE VAN DE OPHANGSTRIPPEN |          |     |          |         |      |       |
|-------------------------------|----------|-----|----------|---------|------|-------|
| TYPE                          | L        | X   | Y(≥1800) | H       | H1   | H2    |
| 10                            | 500-2000 | 140 | L/2      | 400-900 | H-54 | H-153 |
| 11                            | 400-3000 | 85  | L/2      | 300-950 | H-54 | H-153 |
| 20-33                         | 400      | 100 | L/2      | 300-950 | H-54 | H-153 |
|                               | 400-3000 | 140 |          |         |      |       |

# Verticale RADIATOREN

## VERTI M KOMPAKT (GALVA)

De Superia Verti M Kompakt is een verticale paneelradiator in een compacte stijlvolle vorm. Deze combineert een superieure warmtevoorziening met een toekomstgerichte technologie en een stijlvolle uitstraling. Door zijn mix van eenvoud, efficiëntie en esthetiek, nog versterkt door de slimme, vaste **middenaansluiting**, vormt de verticale paneelradiator een harmonisch geheel in elke woon- en werkruimte.

|                                  |  |
|----------------------------------|--|
| <b>Product:</b>                  | Verticale paneelradiator met zowel een middenaansluiting (onder) als twee zijkantaansluitingen (onder). De twee bovenaansluitingen zijn voor de plaatsing van de ontluchter.   |
| <b>Materiaal:</b>                | Staal  |
| <b>Afwerking:</b>                | Zijbekledingen   |
| <b>Ophanging en toebehoren:</b>  | J-console set (standaard meegeleverd), Conform VDI 6036 (klasse III)<br>Blindstop (1x) en ontluchter (1x) meegeleverd met de ophanging.<br>Blindstop in aansluiting linksboven (4) en linksonder (1) reeds voormonteerd in de fabriek. |
| <b>Aansluitingen:</b>            | 4 x ½" bi (1 en 4 reeds afgedicht in de fabriek),<br>2 x ¾" bu (midden onderkant) (reeds afgedicht in de fabriek)  |
| <b>Verpakking:</b>               | Iedere radiator wordt stevig verpakt in hoogwaardig karton.<br>Een etiket beschrijft de radiator karakteristieken: type – hoogte – lengte.   |
| <b>Garantie:</b>                 | 10 jaar, indien men de algemene voorwaarden van Superia respecteert.   |
| <b>Lakproces:</b>                | Alle radiatoren zijn ontvet, gefosfateerd, kataforetisch gegrondlakt en standaard in Superia wit gepoederlakt.   |
| <b>Galva:</b>                    | Elektrolytisch verzinken   |
| <b>Kleur:</b>                    | Superia wit (op aanvraag ook leverbaar in andere kleuren: zie kleurenkaart)  |
| <b>Warmtetellers:</b>            | Zonder beperkingen geschikt voor warmtetellers, zowel elektrisch als volgens verdampingsprincipe (overeenkomstig EN834 835).   |
| <b>Max. werkdruk:</b>            | 8 bar (getest op 10,4 bar)   |
| <b>Max. bedrijfstemperatuur:</b> | 110 °C   |
| <b>Conformiteit:</b>             | Volgens EN442-1: 2014: radiatoren en convectoren   |
| <b>Types:</b>                    | 21s   22 (Galva)   |
| <b>Hoogtes:</b>                  | 1600   1800 (Galva)   2000 (Galva)   2200 mm   |
| <b>Lengtes:</b>                  | 400   500 (Galva)   600 (Galva)   700   800 mm   |
| <b>Dieptes:</b>                  | <b>Type 21s:</b> 73   <b>Type 22:</b> 106 mm   |

TYPE 21s



TYPE 22



# Central

TECHNISCHE GEGEVENS PER LOPENDE METER BIJ 75/65/20°C

| Hoogte (mm) |    | Type 21s | Type 22 |
|-------------|----|----------|---------|
| 1600        | W  | 2962     | 3608    |
|             | kg | 77,60    | 86,16   |
|             | l  | 13,38    | 13,63   |
|             | n  | 1,35     | 1,38    |
| 1800        | W  | 3242     | 3896    |
|             | kg | 83,92    | 94,58   |
|             | l  | 15,13    | 16,46   |
|             | n  | 1,34     | 1,36    |
| 2000        | W  | 3516     | 4190    |
|             | kg | 90,22    | 103,00  |
|             | l  | 16,88    | 19,29   |
|             | n  | 1,32     | 1,33    |
| 2200        | W  | 3782     | 4488    |
|             | kg | 98,50    | 111,62  |
|             | l  | 19,38    | 22,14   |
|             | n  | 1,36     | 1,45    |

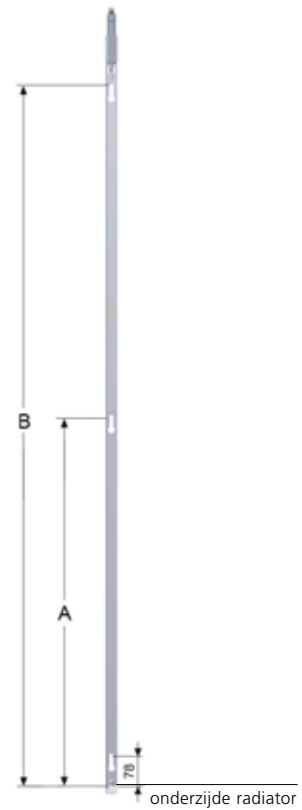

TECHNISCHE TEKENINGEN VERTI M KOMPAKT (GALVA)

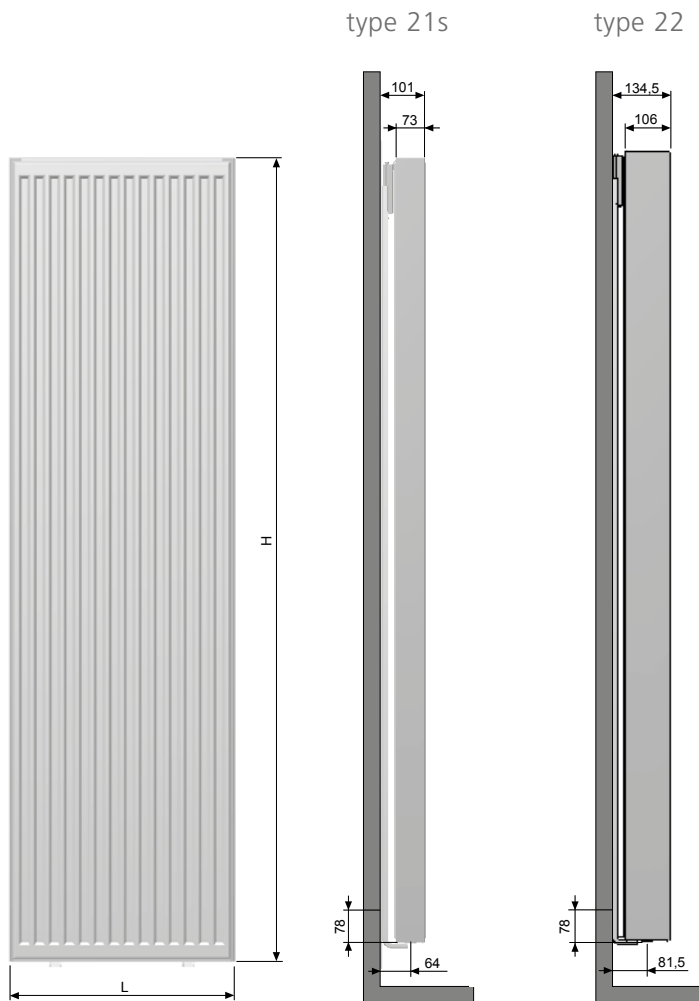

Vooraanzicht

Zijaanzicht

| H    | A    | B    |
|------|------|------|
| 1600 | 748  | 1418 |
| 1800 | 848  | 1618 |
| 2000 | 948  | 1818 |
| 2200 | 1048 | 2018 |

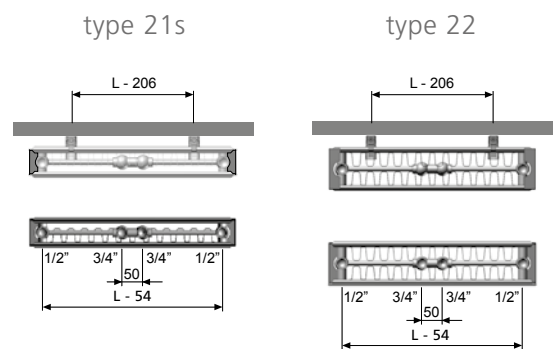

Onderaanzicht

## VERTI M DESIGN

De Superia Verti M Design paneelradiator is een verticale paneelradiator met vlakke voorplaat. Deze combineert een superieure warmtevoorziening met een toekomstgerichte technologie en een stijlvolle uitstraling. Door zijn mix van eenvoud, efficiëntie en esthetiek, nog versterkt door de slimme, vaste **middenaansluiting**, vormt de paneelradiator een harmonisch geheel in elke woon- en werkruimte.

|                                  |   |
|----------------------------------|---|
| <b>Product:</b>                  | Verticale paneelradiator met zowel een middenaansluiting (onder) als twee zijkantaansluitingen (onder). De twee bovenaansluitingen zijn voor de plaatsing van de ontluchter. De radiator is bekleed met een vlakke voorplaat.               |
| <b>Materiaal:</b>                | Staal   |
| <b>Afwerking:</b>                | Zijbekledingen en vlakke voorplaat  |
| <b>Ophanging en toebehoren:</b>  | J-console set (standaard meegeleverd), Conform VDI 6036 (klasse III)<br>Blindstop (1x) en ontluchter (1x) meegeleverd met de ophanging.<br>Blindstop in aansluiting linksboven (4) en linksonder (1) reeds voorgeïnstalleerd in de fabriek. |
| <b>Aansluitingen:</b>            | 4 x ½" bi (1 en 4 reeds afgedicht in de fabriek),<br>2 x ¾" bu (midden onderkant) (reeds afgedicht in de fabriek)   |
| <b>Verpakking:</b>               | Iedere radiator wordt stevig verpakt in hoogwaardig karton.<br>Een etiket beschrijft de radiatorcarakteristieken: type – hoogte – lengte.   |
| <b>Garantie:</b>                 | 10 jaar, indien men de algemene voorwaarden van Superia respecteert.  |
| <b>Lakproces:</b>                | Alle radiatoren zijn ontvet, gefosfateerd, kataforetisch gegrondlakt en standaard in Superia wit gepoederlakt.  |
| <b>Kleur:</b>                    | Superia wit (op aanvraag ook leverbaar in andere kleuren: zie kleurenkaart)   |
| <b>Warmteters:</b>               | Zonder beperkingen geschikt voor warmteters, zowel elektrisch als volgens verdampingsprincipe (overeenkomstig EN834 835).   |
| <b>Max. werkdruk:</b>            | 8 bar (getest op 10,4 bar)  |
| <b>Max. bedrijfstemperatuur:</b> | 110 °C  |
| <b>Conformiteit:</b>             | Volgens EN442-1: 2014: radiatoren en convectoren  |
| <b>Types:</b>                    | 21s   22  |
| <b>Hoogtes:</b>                  | 1600   1800   2000   2200 mm  |
| <b>Lengtes:</b>                  | 400   500   600   700   800 mm  |
| <b>Dieptes:</b>                  | <b>Type 21s:</b> 74,5   <b>Type 22:</b> 107,5 mm  |

TYPE 21s



TYPE 22



# Central

TECHNISCHE GEGEVENS PER LOPENDE METER BIJ 75/65/20°C

| Hoogte (mm) |    | Type 21s | Type 22 |
|-------------|----|----------|---------|
| 1600        | W  | 2618     | 3202    |
|             | kg | 88,38    | 99,66   |
|             | l  | 13,38    | 13,63   |
|             | n  | 1,33     | 1,40    |
| 1800        | W  | 2800     | 3486    |
|             | kg | 98,36    | 109,48  |
|             | l  | 15,13    | 16,46   |
|             | n  | 1,35     | 1,44    |
| 2000        | W  | 2996     | 3772    |
|             | kg | 108,36   | 119,30  |
|             | l  | 16,88    | 19,29   |
|             | n  | 1,36     | 1,48    |
| 2200        | W  | 3208     | 4064    |
|             | kg | 117,10   | 130,20  |
|             | l  | 19,38    | 22,14   |
|             | n  | 1,46     | 1,35    |

## TECHNISCHE TEKENINGEN VERTI M DESIGN

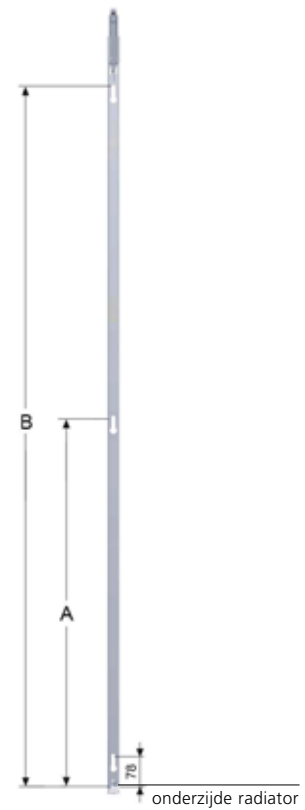
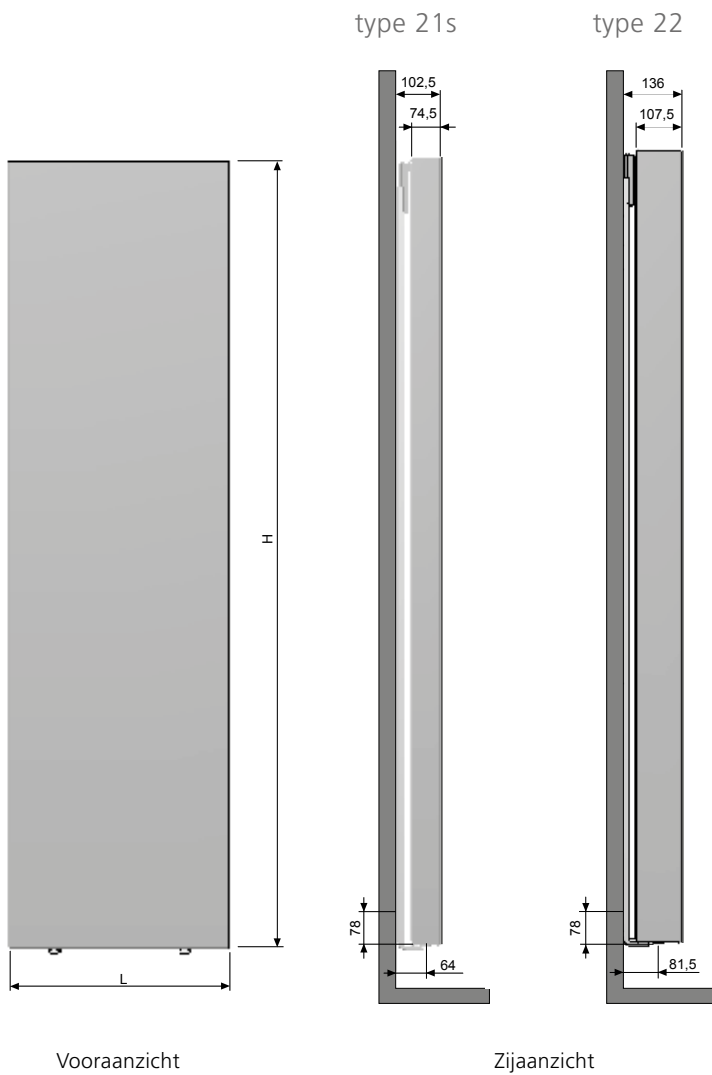

| H    | A    | B    |
|------|------|------|
| 1600 | 748  | 1418 |
| 1800 | 848  | 1618 |
| 2000 | 948  | 1818 |
| 2200 | 1048 | 2018 |

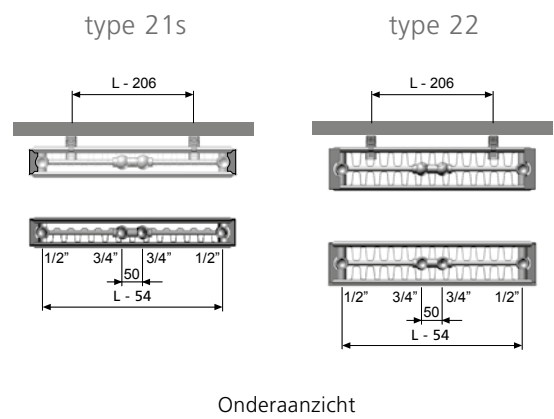

## VERTI M LINE

De Superia Verti M Line is een verticale paneelradiator met vlakke voorplaat voorzien van verticale lijnen. Deze combineert een superieure warmtevoorziening met een toekomstgerichte technologie en een stijlvolle uitstraling. Door zijn mix van eenvoud, efficiëntie en esthetiek, nog versterkt door de slimme, vaste **middenaansluiting**, vormt de paneelradiator een harmonisch geheel in elke woon- en werkruimte.

|                                  |   |
|----------------------------------|---|
| <b>Product:</b>                  | Verticale paneelradiator met zowel een middenaansluiting (onder) als twee zijkantaansluitingen (onder). De twee bovenaansluitingen zijn voor de plaatsing van de ontluchter. De radiator is bekleed met een vlakke voorplaat voorzien van verticale lijnen. |
| <b>Materiaal:</b>                | Staal   |
| <b>Afwerking:</b>                | Zijbekledingen en vlakke voorplaat met verticale lijnen   |
| <b>Ophanging en toebehoren:</b>  | J-console set (standaard meegeleverd), Conform VDI 6036 (klasse III)<br>Blindstop (1x) en ontluchter (1x) meegeleverd met de ophanging.<br>Blindstop in aansluiting linksboven (4) en linksonder (1) reeds voorgemonteerd in de fabriek.                    |
| <b>Aansluitingen:</b>            | 4 x ½" bi (1 en 4 reeds afgedicht in de fabriek),<br>2 x ¾" bu (midden onderkant) (reeds afgedicht in de fabriek)   |
| <b>Verpakking:</b>               | Iedere radiator wordt stevig verpakt in hoogwaardig karton.<br>Een etiket beschrijft de radiator karakteristieken: type – hoogte – lengte.  |
| <b>Garantie:</b>                 | 10 jaar, indien men de algemene voorwaarden van Superia respecteert.  |
| <b>Lakproces:</b>                | Alle radiatoren zijn ontvet, gefosfateerd, kataforetisch gegrondlakt en standaard in Superia wit gepoederlakt.  |
| <b>Kleur:</b>                    | Superia wit (op aanvraag ook leverbaar in andere kleuren: zie kleurenkaart)   |
| <b>Warmtetellers:</b>            | Zonder beperkingen geschikt voor warmtetellers, zowel elektrisch als volgens verdampingsprincipe (overeenkomstig EN834 835).  |
| <b>Max. werkdruk:</b>            | 8 bar (getest op 10,4 bar)  |
| <b>Max. bedrijfstemperatuur:</b> | 110 °C  |
| <b>Conformiteit:</b>             | Volgens EN442-1: 2014: radiatoren en convectoren  |
| <b>Types:</b>                    | 21s   22  |
| <b>Hoogtes:</b>                  | 1600   1800   2000   2200 mm  |
| <b>Lengtes:</b>                  | 400   500   600   700   800 mm  |
| <b>Dieptes:</b>                  | <b>Type 21s:</b> 74,5   <b>Type 22:</b> 107,5 mm  |

TYPE 21s



TYPE 22





# Central

TECHNISCHE GEGEVENS PER LOPENDE METER BIJ 75/65/20°C

| Hoogte (mm) |    | Type 21s | Type 22 |
|-------------|----|----------|---------|
| 1600        | W  | 2618     | 3202    |
|             | kg | 88,38    | 99,66   |
|             | l  | 13,38    | 13,63   |
|             | n  | 1,33     | 1,40    |
| 1800        | W  | 2800     | 3486    |
|             | kg | 98,36    | 109,48  |
|             | l  | 15,13    | 16,46   |
|             | n  | 1,35     | 1,44    |
| 2000        | W  | 2996     | 3772    |
|             | kg | 108,36   | 119,30  |
|             | l  | 16,88    | 19,29   |
|             | n  | 1,36     | 1,48    |
| 2200        | W  | 3208     | 4064    |
|             | kg | 117,10   | 130,20  |
|             | l  | 19,38    | 22,14   |
|             | n  | 1,46     | 1,35    |

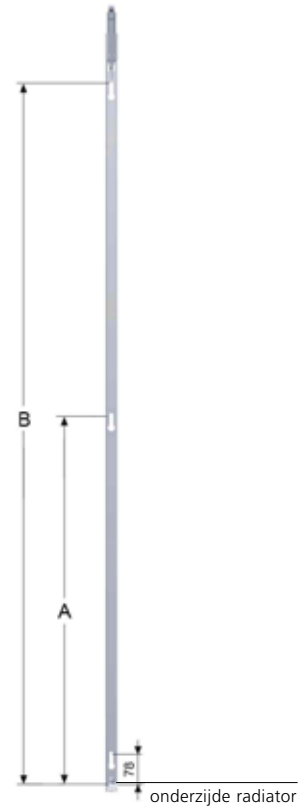

## TECHNISCHE TEKENINGEN VERTI M LINE

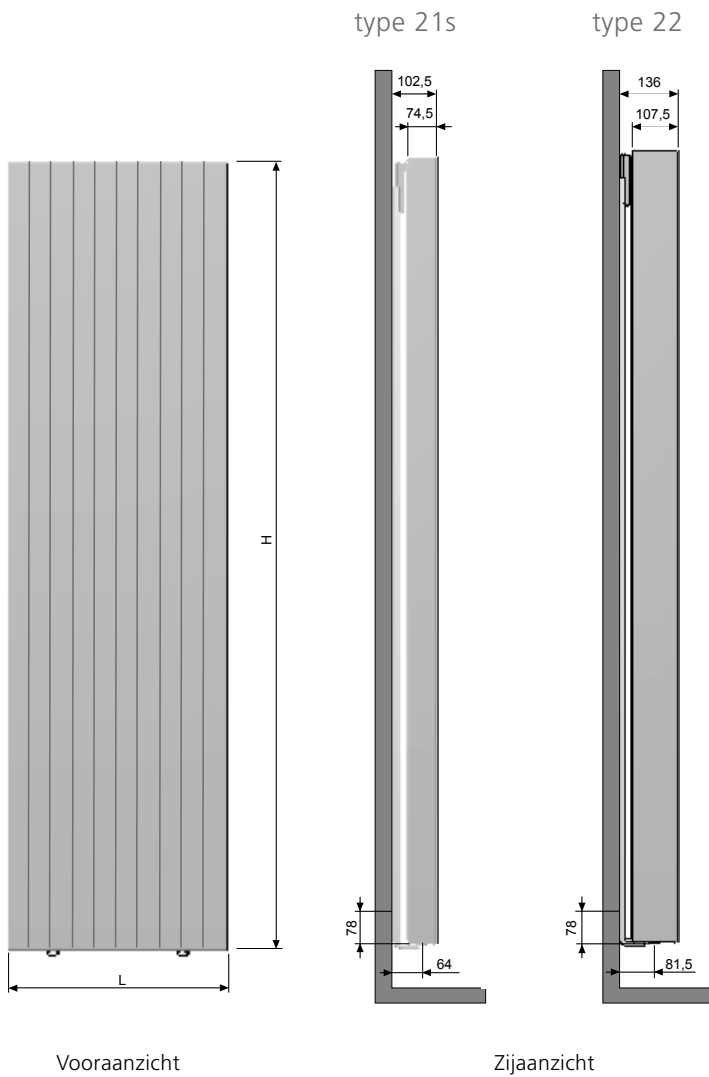

| H    | A    | B    |
|------|------|------|
| 1600 | 748  | 1418 |
| 1800 | 848  | 1618 |
| 2000 | 948  | 1818 |
| 2200 | 1048 | 2018 |

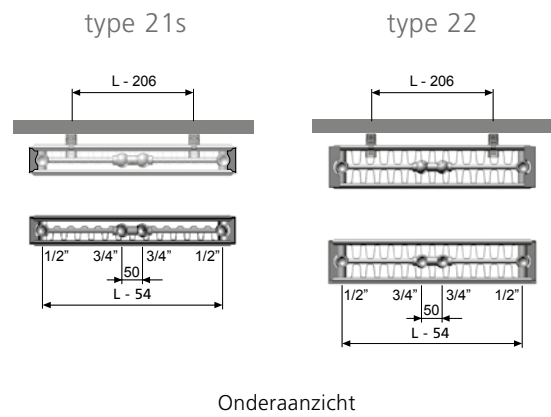

VERTI M KOMPAKT (GALVA)

VERTI M DESIGN

VERTI M LINE

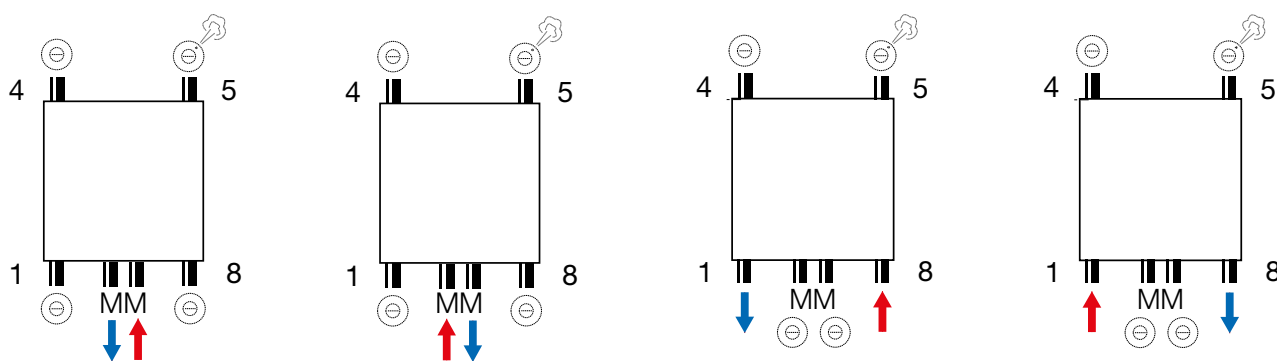

\*Opmerking: geen bovenaansluiting mogelijk

# Mini RADIATOREN



## MINI SUPER 6 UNIVERSEEL STANDAARD

De Superia Mini Super 6 Universeel Standaard is een plintradiator op maat van elk interieur, elke ruimte, elke raampartij. Ze is discreet in uw interieur aanwezig, maar gul met warmte door de bestudeerde, gedwongen waterloop. Hierdoor kunt u zeker zijn van een maximale warmteafgifte, terwijl u op een slimme manier ruimte bespaart in uw interieur en euro's op uw energiefactuur.

De Mini Super 6 Universeel Standaard is verkrijgbaar in een wandmodel of vrijstaande opstelling.

|                                  |   |
|----------------------------------|---|
| <b>Product:</b>                  | Plintradiator met zowel een rechteronderaansluiting als vier zijdelingse aansluitingen met meegeleverd ventielinsert (click-systeem). Door het gebruik van de consoles is het mogelijk de radiator te spiegelen zodat de thermostaatknop links of rechts kan gemonteerd worden. |
| <b>Materiaal:</b>                | Staal   |
| <b>Afwerking:</b>                | Standaard   |
| <b>Blindstop en ontluchter:</b>  | Apart te bestellen<br>13911990031 blindstop ½" (10 stuks)<br>13911990040 ontluchter ½" (1 stuk)   |
| <b>Aansluitingen:</b>            | 2 x ¾" buitendraadse euroconus rechteronderaansluiting,<br>4 x ½" binnendraad aansluitingen   |
| <b>Verpakking:</b>               | Iedere radiator wordt stevig verpakt in hoogwaardig karton.<br>Een etiket beschrijft de radiator karakteristieken: type – hoogte – lengte.  |
| <b>Garantie:</b>                 | 10 jaar, indien men de algemene voorwaarden van Superia respecteert.  |
| <b>Lakproces:</b>                | Alle radiatoren zijn ontvet, gefosfateerd, kataforetisch gegrondlakt en standaard in Superia wit gepoederlakt.  |
| <b>Kleur:</b>                    | Superia wit<br>(op aanvraag ook leverbaar in andere kleuren: zie kleurenkaart)  |
| <b>Max. werkdruk:</b>            | 8 bar (getest op 10,4 bar)  |
| <b>Max. bedrijfstemperatuur:</b> | 110 °C  |
| <b>Conformiteit:</b>             | Volgens EN442-1: 2014: radiatoren en convectoren  |
| <b>Types:</b>                    | 22   33   34  |
| <b>Hoogtes:</b>                  | 150   200 mm  |
| <b>Lengtes:</b>                  | 800 => 3000 mm  |
| <b>Dieptes:</b>                  | 98   167   184 mm   |

TYPE 22 / 33 / 34

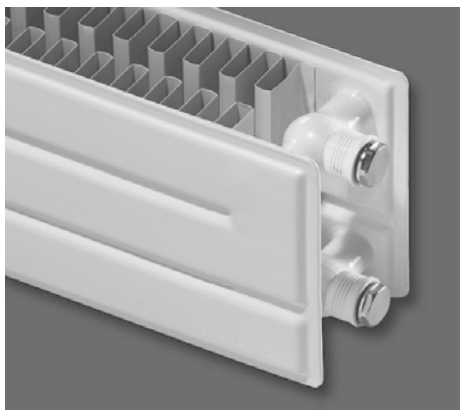

TECHNISCHE GEGEVENS PER LOPENDE METER BIJ 75/65/20°C

| Hoogte (mm) |    | Type 22 | Type 33 | Type 34 |
|-------------|----|---------|---------|---------|
| 150         | W  | 646     | 945     | 1099    |
|             | kg | 10,00   | 15,25   | 16,70   |
|             | l  | 2,25    | 3,45    | 3,50    |
|             | n  | 1,26    | 1,26    | 1,25    |
| 200         | W  | 769     | 1112    | 1293    |
|             | kg | 13,10   | 19,70   | 21,75   |
|             | l  | 2,90    | 4,35    | 4,40    |
|             | n  | 1,26    | 1,26    | 1,27    |

## TECHNISCHE TEKENINGEN MINI SUPER 6 UNIVERSEEL STANDAARD

type 22

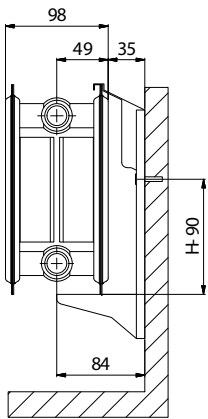

type 33

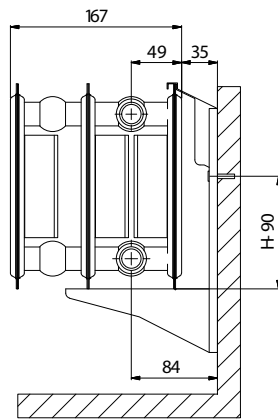

type 34

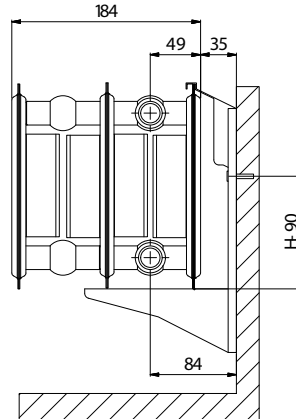

### CONSOLES

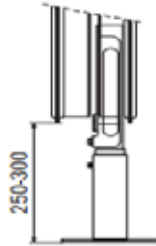
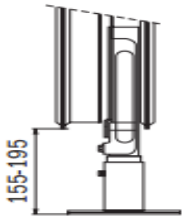

Gedwongen waterloop voor een hoge afgifte

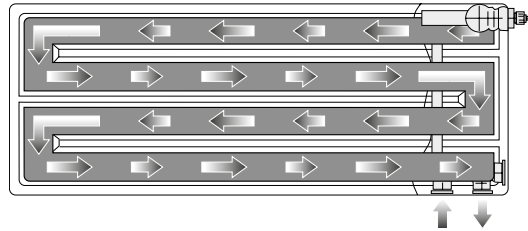

Vrijstaande console vloer versie



Vrijstaande console chape versie (cementdekvloer)



Wandconsole type 22



Wandconsole type 33/34



## MINI SUPER 6 UNIVERSEEL KOMPAKT

De Superia Mini Super 6 Universeel Kompakt is een plintradiator op maat van elk interieur, elke ruimte, elke raampartij en is afgewerkt met een sierrooster en zijbekledingen. Ze is discreet in uw interieur aanwezig, maar gul met warmte door de bestudeerde, gedwongen waterloop. Hierdoor kunt u zeker zijn van een maximale warmteafgifte, terwijl u op een slimme manier ruimte bespaart in uw interieur en euro's op uw energiefactuur. De Mini Super 6 Universeel Kompakt is verkrijgbaar in een wandmodel of vrijstaande opstelling.

|                                  |   |
|----------------------------------|---|
| <b>Product:</b>                  | Plintradiator met zowel een rechteronderaansluiting als vier zijdelingse aansluitingen met meegeleverd ventielinsert (click-systeem). Door het gebruik van de consoles is het mogelijk de radiator te spiegelen zodat de thermostaatknop links of rechts kan gemonteerd worden. |
| <b>Materiaal:</b>                | Staal   |
| <b>Afwerking:</b>                | Bovenrooster en zijbekledingen  |
| <b>Blindstop en ontluchter:</b>  | Apart te bestellen<br>13911990031 blindstop ½" (10 stuks)<br>13911990040 ontluchter ½" (1 stuk)   |
| <b>Aansluitingen:</b>            | 2 x ¾" buitendraadse euroconus rechteronderaansluiting,<br>4 x ½" binnendraad aansluitingen   |
| <b>Verpakking:</b>               | Iedere radiator wordt stevig verpakt in hoogwaardig karton.<br>Een etiket beschrijft de radiator karakteristieken: type – hoogte – lengte.  |
| <b>Garantie:</b>                 | 10 jaar, indien men de algemene voorwaarden van Superia respecteert.  |
| <b>Lakproces:</b>                | Alle radiatoren zijn ontvet, gefosfateerd, kataforetisch gegrondlakt en standaard in Superia wit gepoederlakt.  |
| <b>Kleur:</b>                    | Superia wit<br>(op aanvraag ook leverbaar in andere kleuren: zie kleurenkaart)  |
| <b>Max. werkdruk:</b>            | 8 bar (getest op 10,4 bar)  |
| <b>Max. bedrijfstemperatuur:</b> | 110 °C  |
| <b>Conformiteit:</b>             | Volgens EN442-1: 2014: radiatoren en convectoren  |
| <b>Types:</b>                    | 22   33   34  |
| <b>Hoogtes:</b>                  | 150   200 mm  |
| <b>Lengtes:</b>                  | 800 => 3000 mm  |
| <b>Dieptes:</b>                  | 98   167   184 mm   |



TECHNISCHE GEGEVENS PER LOPENDE METER BIJ 75/65/20°C

| Hoogte (mm) |    | Type 22 | Type 33 | Type 34 |
|-------------|----|---------|---------|---------|
| 150         | W  | 591     | 844     | 984     |
|             | kg | 10,30   | 16,12   | 17,58   |
|             | l  | 2,30    | 3,50    | 3,60    |
|             | n  | 1,24    | 1,24    | 1,24    |
| 200         | W  | 715     | 1029    | 1205    |
|             | kg | 13,29   | 20,51   | 22,34   |
|             | l  | 3,10    | 3,50    | 4,70    |
|             | n  | 1,25    | 1,26    | 1,26    |

## TECHNISCHE TEKENINGEN MINI SUPER 6 UNIVERSEEL KOMPAKT

type 22

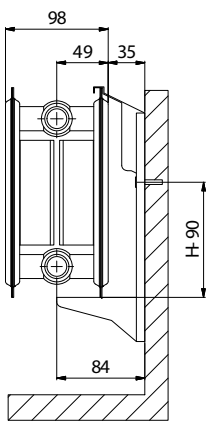

type 33

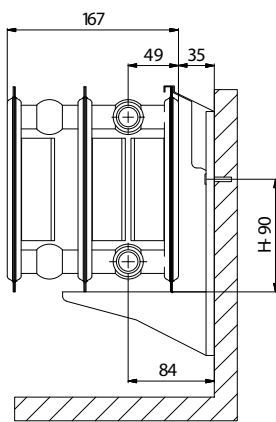

type 34

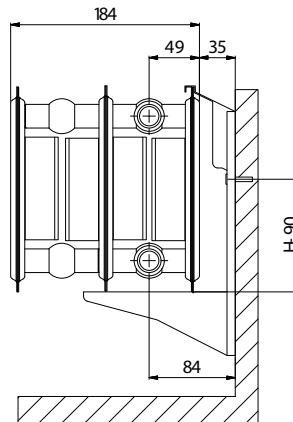

### CONSOLES

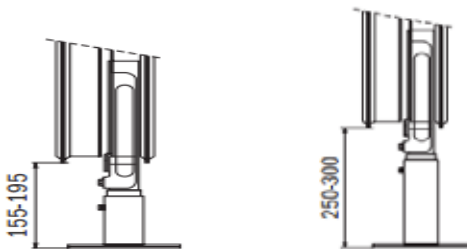

Gedwongen waterloop voor een hoge afgifte

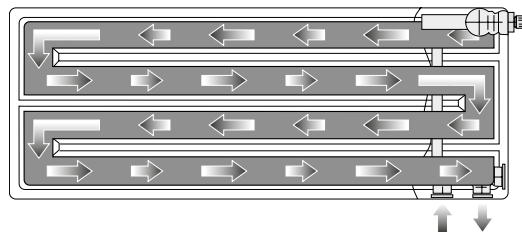

Vrijstaande console vloer versie



Vrijstaande console chape versie (cementdekvloer)



Wandconsole type 22



Wandconsole type 33/34



## MINI SUPER 6 DESIGN 1

De Superia Mini Super 6 Design 1 is een plintradiator met enkele vlakke voorplaat. De strakke, vlakke body, de fijne, feilloze afwerking met vlakke voorplaat zorgt voor een oogstrelend resultaat. Ze is discreet in uw interieur aanwezig, maar gul met warmte door de bestudeerde, gedwongen waterloop. Hierdoor kunt u zeker zijn van een maximale warmteafgifte, terwijl u op een slimme manier ruimte bespaart in uw interieur en euro's op uw energiefactuur. De Mini Super 6 Design 1 met enkele vlakke voorplaat is verkrijgbaar in een wandmodel of vrijstaande opstelling.

|                                  |   |
|----------------------------------|---|
| <b>Product:</b>                  | Plintradiator met zowel een rechteronderaansluiting als vier zijdelingse aansluitingen met meegeleverd ventielinsert (click-systeem). Door het gebruik van de consoles is het mogelijk de radiator te spiegelen zodat de thermostaatknop links of rechts kan gemonteerd worden. |
| <b>Materiaal:</b>                | Staal   |
| <b>Afwerking:</b>                | Bovenrooster, zijbekledingen en vlakke voorplaat aan één zijde  |
| <b>Blindstop en ontluucher:</b>  | Apart te bestellen<br>13911990031 blindstop ½" (10 stuks)<br>13911990040 ontluucher ½" (1 stuk)   |
| <b>Aansluitingen:</b>            | 2 x ¾" buitendraadse euroconus rechteronderaansluiting,<br>4 x ½" binnendraad aansluitingen   |
| <b>Verpakking:</b>               | Iedere radiator wordt stevig verpakt in hoogwaardig karton.<br>Een etiket beschrijft de radiatorkenmerken: type – hoogte – lengte.  |
| <b>Garantie:</b>                 | 10 jaar, indien men de algemene voorwaarden van Superia respecteert.  |
| <b>Lakproces:</b>                | Alle radiatoren zijn ontvet, gefosfateerd, kataforetisch gegrondlakt en standaard in Superia wit gepoederlakt.  |
| <b>Kleur:</b>                    | Superia wit<br>(op aanvraag ook leverbaar in andere kleuren: zie kleurenkaart)  |
| <b>Max. werkdruk:</b>            | 8 bar (getest op 10,4 bar)  |
| <b>Max. bedrijfstemperatuur:</b> | 110 °C  |
| <b>Conformiteit:</b>             | Volgens EN442-1: 2014: radiatoren en convectoren  |
| <b>Types:</b>                    | 22   33   34  |
| <b>Hoogtes:</b>                  | 150   200 mm  |
| <b>Lengtes:</b>                  | 800 => 3000 mm  |
| <b>Dieptes:</b>                  | 100   169   186 mm  |





TECHNISCHE GEGEVENS PER LOPENDE METER BIJ 75/65/20°C

| Hoogte (mm) |    | Type 22 | Type 33 | Type 34 |
|-------------|----|---------|---------|---------|
| 150         | W  | 591     | 848     | 1014    |
|             | kg | 12,25   | 18,25   | 19,80   |
|             | l  | 2,30    | 3,50    | 3,60    |
|             | n  | 1,23    | 1,24    | 1,25    |
| 200         | W  | 688     | 1011    | 1189    |
|             | kg | 15,85   | 23,20   | 25,30   |
|             | l  | 3,10    | 4,60    | 4,70    |
|             | n  | 1,25    | 1,27    | 1,25    |

## TECHNISCHE TEKENINGEN MINI SUPER 6 DESIGN 1

type 22

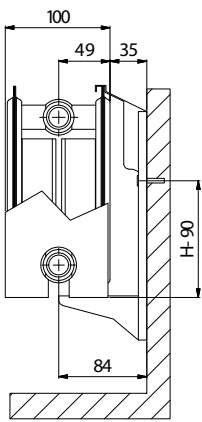

type 33

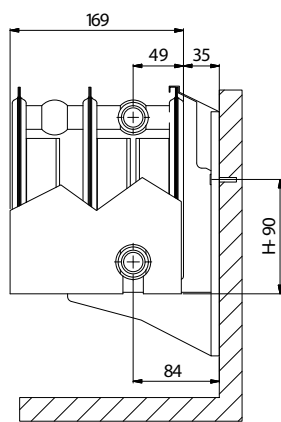

type 34

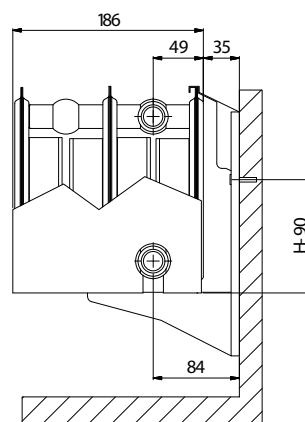

### CONSOLES

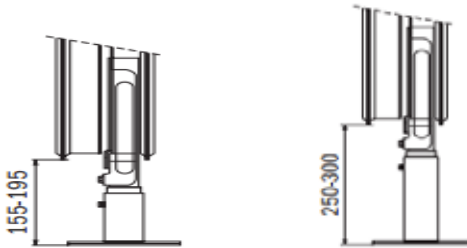

### Gedwongen waterloop voor een hoge afgifte

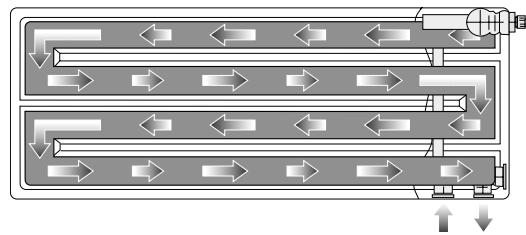

Vrijstaande console vloer versie



Vrijstaande console chape versie (cementdekvloer)



Wandconsole type 22



Wandconsole type 33/34



## MINI SUPER 6 DESIGN 2

De Superia Mini Super 6 Design 2 is een plintradiator met dubbele vlakke voorplaat. De strakke, vlakke body, de fijne, feilloze afwerking met vlakke voorplaat zorgt voor een oogstrelend resultaat. Ze is discreet in uw interieur aanwezig, maar gul met warmte door de bestudeerde, gedwongen waterloop. Hierdoor kunt u zeker zijn van een maximale warmteafgifte, terwijl u op een slimme manier ruimte bespaart in uw interieur en euro's op uw energiefactuur.

De Mini Super 6 Design 2 met dubbele vlakke voorplaat is alleen verkrijgbaar in vrijstaande opstelling.

|                                  |   |
|----------------------------------|---|
| <b>Product:</b>                  | Plintradiator met zowel een rechteronderaansluiting als vier zijdelingse aansluitingen met meegeleverd ventielinsert (click-systeem). Door het gebruik van de consoles is het mogelijk de radiator te spiegelen zodat de thermostaatknop links of rechts kan gemonteerd worden. |
| <b>Materiaal:</b>                | Staal   |
| <b>Afwerking:</b>                | Bovenrooster, zijbekledingen en vlakke voorplaat aan beide zijden   |
| <b>Blindstop en ontluchter:</b>  | Apart te bestellen<br>13911990031 blindstop ½" (10 stuks)<br>13911990040 ontluchter ½" (1 stuk)   |
| <b>Aansluitingen:</b>            | 2 x ¾" buitendraadse euroconus rechteronderaansluiting,<br>4 x ½" binnendraad aansluitingen   |
| <b>Verpakking:</b>               | Iedere radiator wordt stevig verpakt in hoogwaardig karton.<br>Een etiket beschrijft de radiator karakteristieken: type – hoogte – lengte.  |
| <b>Garantie:</b>                 | 10 jaar, indien men de algemene voorwaarden van Superia respecteert.  |
| <b>Lakproces:</b>                | Alle radiatoren zijn ontvet, gefosfateerd, kataforetisch gegrondlakt en standaard in Superia wit gepoederlakt.  |
| <b>Kleur:</b>                    | Superia wit<br>(op aanvraag ook leverbaar in andere kleuren: zie kleurenkaart)  |
| <b>Max. werkdruk:</b>            | 8 bar (getest op 10,4 bar)  |
| <b>Max. bedrijfstemperatuur:</b> | 110 °C  |
| <b>Conformiteit:</b>             | Volgens EN442-1: 2014: radiatoren en convectoren  |
| <b>Types:</b>                    | 22   33   34  |
| <b>Hoogtes:</b>                  | 150   200 mm  |
| <b>Lengtes:</b>                  | 800 => 3000 mm  |
| <b>Dieptes:</b>                  | 102   171   188 mm  |

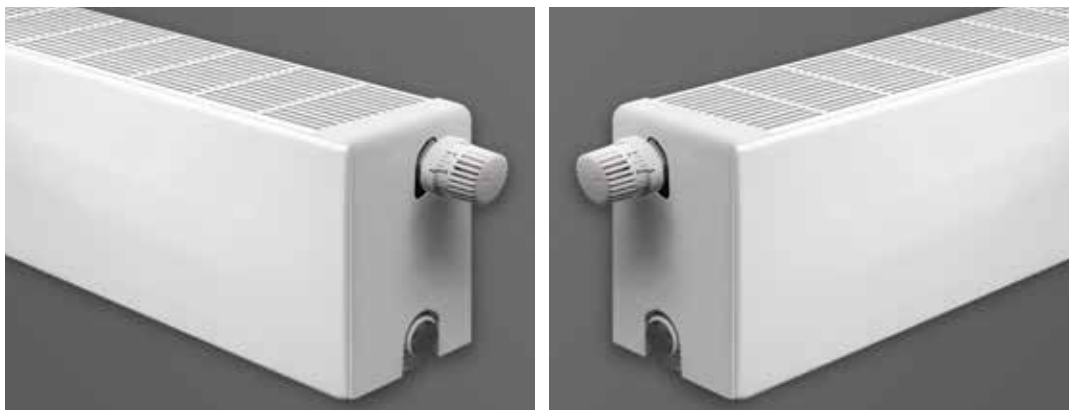

# Mini

TECHNISCHE GEGEVENS PER LOPENDE METER BIJ 75/65/20°C

| Hoogte (mm) |    | Type 22 | Type 33 | Type 34 |
|-------------|----|---------|---------|---------|
| 150         | W  | 573     | 827     | 965     |
|             | kg | 13,06   | 18,88   | 20,33   |
|             | l  | 2,30    | 3,50    | 3,60    |
|             | n  | 1,23    | 1,22    | 1,22    |
| 200         | W  | 684     | 999     | 1171    |
|             | kg | 16,82   | 24,05   | 25,88   |
|             | l  | 3,10    | 4,60    | 4,70    |
|             | n  | 1,24    | 1,24    | 1,25    |

## TECHNISCHE TEKENINGEN MINI SUPER 6 DESIGN 2

type 22

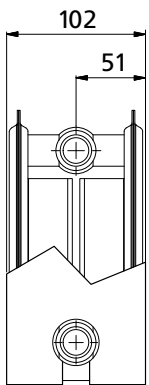

type 33

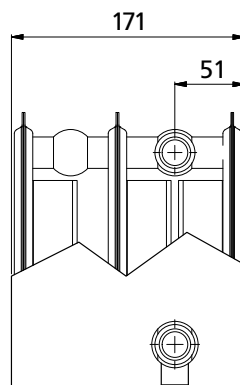

type 34

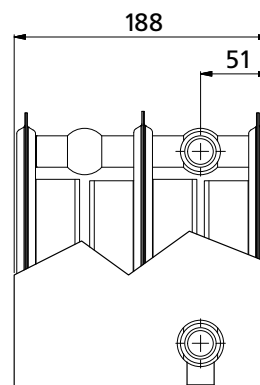

### CONSOLES

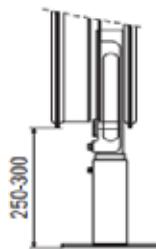
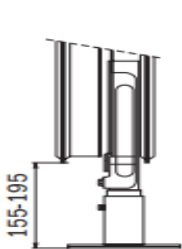

### Gedwongen waterloop voor een hoge afgifte

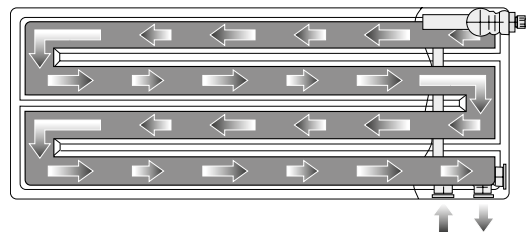

Vrijstaande console vloer versie



Vrijstaande console chape versie (cementdekvloer)



MINI SUPER 6 UNIVERSEEL STANDAARD - MINI SUPER 6 UNIVERSEEL KOMPAKT  
 MINI SUPER 6 DESIGN 1 - MINI SUPER 6 DESIGN 2

Mede door de gedwongen waterloop zijn zeer veel verschillende aansluitvarianten mogelijk.

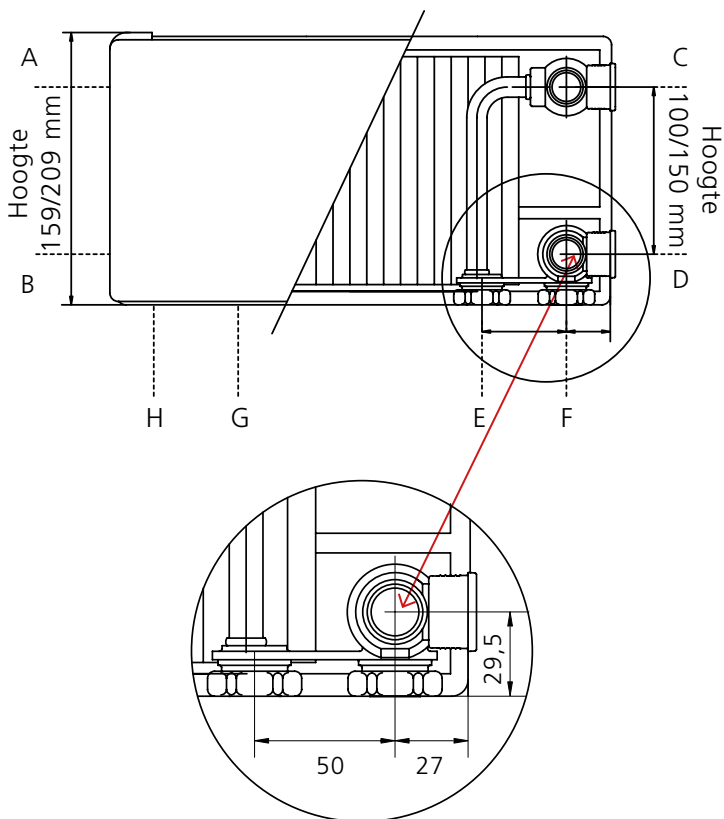

**AANSLUITINGEN**

**De aansluitingen zijn als volgt:\***

- A** 1/2" binnendraad  
evt. geschikt voor de ventiel-montage
  - B** 1/2" binnendraad
  - C** 1/2" binnendraad  
evt. geschikt voor de ventiel-montage
  - D** 1/2" binnendraad
  - E/G** 3/4" buitendraad  
(met inwendige Euroconus) (aanvoer)\*
  - F/H** 3/4" buitendraad  
(met inwendige Euroconus) (retour)\*
- \* (Afhankelijk van de bestelcode)

Let op:

**A/G/H alleen door de radiator te draaien**

**LET OP! BELANGRIJK!** Bij elke bestelling de gewenste aansluitvariant volgens het nevenstaand schema aanduiden! Dit brengt geen extra kosten met zich mee.

Gedwongen waterloop voor een hoge afgifte

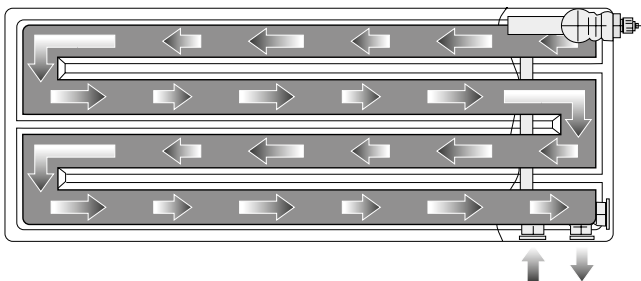

AANSLUITVARIANTEN VOOR PARALLELSYSTEMEN

Hoogte 150mm:

| Aanvoer | Retour | Ontluchter | Code     | AANSLUITINGEN |
|---------|--------|------------|----------|---------------|
| E       | F      | A          | E/F (26) |               |
| G       | H      | C          | G/H (25) |               |
| A       | D      | C          | A/D (10) |               |
| C       | B      | A          | C/B (14) |               |
| A       | B      | C          | A/B (12) |               |
| C       | D      | A          | C/D (13) |               |
| B       | D      | C          | B/D (20) |               |
| D       | B      | A          | D/B (20) |               |

Hoogte 200mm:

| Aanvoer | Retour | Ontluchter | Code     | AANSLUITINGEN |
|---------|--------|------------|----------|---------------|
| E       | F      | A          | E/F (26) |               |
| G       | H      | C          | G/H (25) |               |
| A       | D      | C          | A/D (10) |               |
| C       | B      | A          | C/B (14) |               |
| A       | B      | C          | A/B (12) |               |
| C       | D      | A          | C/D (13) |               |
| B       | D      | C          | B/D (20) |               |
| D       | B      | A          | D/B (20) |               |

VENTIELINSERT (M30 X 1,5)



- SUPER 6
- SUPER 6 DESIGN
- CENTRAL
- CENTRAL DESIGN
- CENTRAL LINE
- MINI

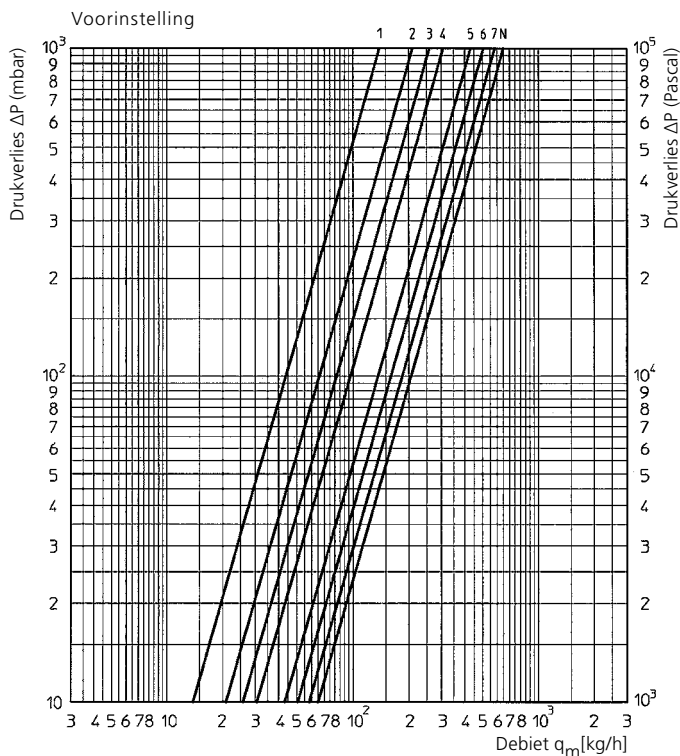

| Type             | Voorinstelling |      |      |      |      |      |                |
|------------------|----------------|------|------|------|------|------|----------------|
|                  | 1              | 2    | 3    | 4    | 5    | 6    | K <sub>v</sub> |
| Insert M30 x 1,5 | 0,05           | 0,13 | 0,27 | 0,42 | 0,60 | 0,70 | 1,50           |

VOORBEELD BEREKENING

Type 22, 600 x 1000mm  
 Vermogen radiator (75/65/20°C) = 1683 Watt

$$T_a = 75 \text{ (}^\circ\text{C)} - T_r = 65 \text{ (}^\circ\text{C)} - T_i = 20 \text{ (}^\circ\text{C)}$$

$$\Delta T = T_a - T_r = 75 \text{ (}^\circ\text{C)} - 65 \text{ (}^\circ\text{C)} = 10 \text{ (}^\circ\text{C)}$$

$$q_m = \frac{P \cdot 3600}{4200 \cdot \Delta T} = \frac{1683 \cdot 3600}{4200 \cdot 10} = 144 \text{ (kg/h)}$$

$$\Delta P = 290 \text{ Pa}$$

T<sub>a</sub> = Temperatuur aanvoer  
 T<sub>r</sub> = Temperatuur retour  
 T<sub>i</sub> = Temperatuur omgeving

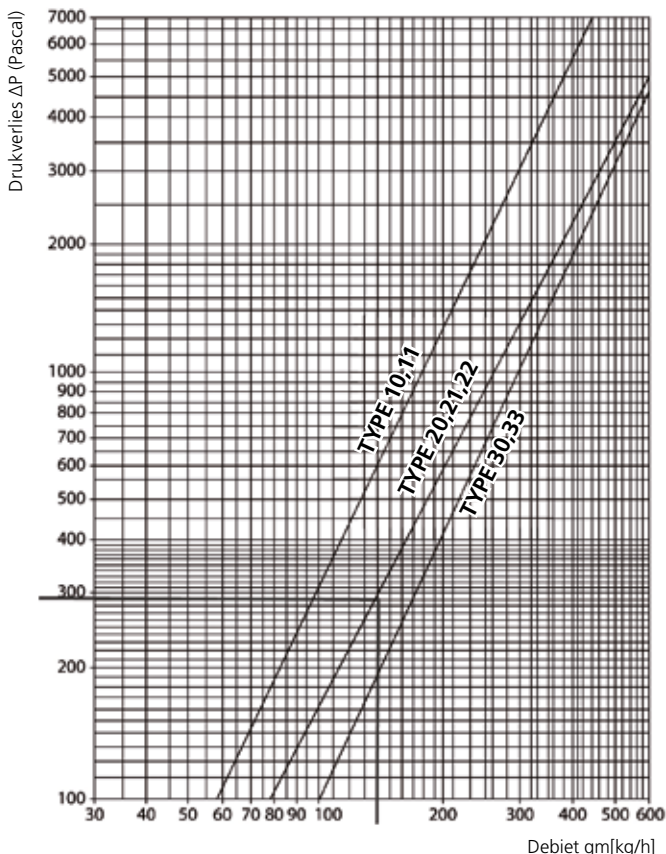



# Casual & Central Collection



# Horizontale

## RADIATOREN



STANDAARD



TYPE 10

Watts 75/65/20 conform EN442-1: 2014: radiatoren en convectoren

| Hoogte (mm)         | 400  | 500  | 600  | 900  |
|---------------------|------|------|------|------|
| W/m 75/65/20 (φ50K) | 425  | 514  | 602  | 872  |
| n-exponent          | 1,26 | 1,27 | 1,29 | 1,29 |
| Lengte (mm)         | Watt | Watt | Watt | Watt |
| 500                 | 213  | 257  | 301  | 436  |
| 600                 | 255  | 308  | 361  | 523  |
| 800                 | 340  | 411  | 482  | 698  |
| 1000                | 425  | 514  | 602  |      |

TYPE 10

Watts 70/55/20 conform EN442-1: 2014: radiatoren en convectoren

| Hoogte (mm)           | 400  | 500  | 600  | 900  |
|-----------------------|------|------|------|------|
| W/m 70/55/20 (φ42,5K) | 344  | 414  | 483  | 700  |
| n-exponent            | 1,26 | 1,27 | 1,29 | 1,29 |
| Lengte (mm)           | Watt | Watt | Watt | Watt |
| 500                   | 172  | 207  | 242  | 350  |
| 600                   | 206  | 248  | 290  | 420  |
| 800                   | 275  | 331  | 387  | 560  |
| 1000                  | 344  | 414  | 483  |      |

TYPE 10

Watts 55/45/20 conform EN442-1: 2014: radiatoren en convectoren

| Hoogte (mm)         | 400  | 500  | 600  | 900  |
|---------------------|------|------|------|------|
| W/m 55/45/20 (φ30K) | 222  | 266  | 309  | 447  |
| n-exponent          | 1,26 | 1,27 | 1,29 | 1,29 |
| Lengte (mm)         | Watt | Watt | Watt | Watt |
| 500                 | 111  | 133  | 154  | 223  |
| 600                 | 133  | 160  | 185  | 268  |
| 800                 | 178  | 213  | 247  | 358  |
| 1000                | 222  | 266  | 309  |      |

## TYPE 11

Watts 75/65/20 conform EN442-1: 2014: radiatoren en convectoren

| Hoogte (mm)         | 300  | 400  | 500  | 600  | 700  | 900  |
|---------------------|------|------|------|------|------|------|
| W/m 75/65/20 (φ50K) | 551  | 697  | 840  | 979  | 1117 | 1390 |
| n-exponent          | 1,22 | 1,24 | 1,25 | 1,27 | 1,28 | 1,30 |
| Lengte (mm)         | Watt | Watt | Watt | Watt | Watt | Watt |
| 400                 |      | 279  | 336  | 392  | 447  | 556  |
| 500                 | 276  | 349  | 420  | 490  | 559  | 695  |
| 600                 | 331  | 418  | 504  | 587  | 670  | 834  |
| 700                 |      |      | 588  | 685  | 782  | 973  |
| 800                 | 441  | 558  | 672  | 783  | 894  | 1112 |
| 900                 |      | 627  | 756  | 881  | 1005 | 1251 |
| 1000                |      | 697  | 840  | 979  | 1117 | 1390 |
| 1200                |      | 836  | 1008 | 1175 | 1340 |      |
| 1400                | 771  | 976  | 1176 | 1371 | 1564 |      |
| 1600                |      | 1115 | 1344 | 1567 |      |      |
| 1800                |      | 1255 | 1512 | 1762 | 2011 |      |
| 2000                |      | 1394 | 1680 | 1958 | 2234 |      |
| 2200                |      | 1534 | 1848 | 2154 |      |      |
| 2400                |      | 1673 | 2016 | 2350 |      |      |

STANDAARD



## TYPE 11

Watts 70/55/20 conform EN442-1: 2014: radiatoren en convectoren

| Hoogte (mm)           | 300  | 400  | 500  | 600  | 700  | 900  |
|-----------------------|------|------|------|------|------|------|
| W/m 70/55/20 (φ42,5K) | 448  | 565  | 679  | 789  | 899  | 1114 |
| n-exponent            | 1,22 | 1,24 | 1,25 | 1,27 | 1,28 | 1,30 |
| Lengte (mm)           | Watt | Watt | Watt | Watt | Watt | Watt |
| 400                   |      | 226  | 272  | 316  | 359  | 446  |
| 500                   | 224  | 283  | 339  | 394  | 449  | 557  |
| 600                   | 269  | 339  | 407  | 473  | 539  | 668  |
| 700                   |      |      | 475  | 552  | 629  | 780  |
| 800                   | 358  | 452  | 543  | 631  | 719  | 891  |
| 900                   |      | 509  | 611  | 710  | 809  | 1003 |
| 1000                  |      | 565  | 679  | 789  | 899  | 1114 |
| 1200                  |      | 678  | 815  | 947  | 1078 |      |
| 1400                  | 627  | 791  | 951  | 1105 | 1258 |      |
| 1600                  |      | 904  | 1086 | 1262 |      |      |
| 1800                  |      | 1017 | 1222 | 1420 | 1617 |      |
| 2000                  |      | 1130 | 1358 | 1578 | 1797 |      |
| 2200                  |      | 1243 | 1494 | 1736 |      |      |
| 2400                  |      | 1356 | 1630 | 1894 |      |      |

## TYPE 11

Watts 55/45/20 conform EN442-1: 2014: radiatoren en convectoren

| Hoogte (mm)         | 300  | 400  | 500  | 600  | 700  | 900  |
|---------------------|------|------|------|------|------|------|
| W/m 55/45/20 (φ30K) | 293  | 368  | 439  | 507  | 576  | 708  |
| n-exponent          | 1,22 | 1,24 | 1,25 | 1,27 | 1,28 | 1,30 |
| Lengte (mm)         | Watt | Watt | Watt | Watt | Watt | Watt |
| 400                 |      | 147  | 176  | 203  | 230  | 283  |
| 500                 | 147  | 184  | 220  | 254  | 288  | 354  |
| 600                 | 176  | 221  | 264  | 304  | 345  | 425  |
| 700                 |      |      | 307  | 355  | 403  | 496  |
| 800                 | 235  | 294  | 351  | 406  | 460  | 567  |
| 900                 |      | 331  | 395  | 457  | 518  | 638  |
| 1000                |      | 368  | 439  | 507  | 576  | 708  |
| 1200                |      | 441  | 527  | 609  | 691  |      |
| 1400                | 411  | 515  | 615  | 710  | 806  |      |
| 1600                |      | 588  | 703  | 812  |      |      |
| 1800                |      | 662  | 791  | 913  | 1036 |      |
| 2000                |      | 736  | 878  | 1015 | 1151 |      |
| 2200                |      | 809  | 966  | 1116 |      |      |
| 2400                |      | 883  | 1054 | 1218 |      |      |

STANDAARD

TYPE 21s Watts 75/65/20 conform EN442-1: 2014: radiatoren en convectoren

| Hoogte (mm)         | 400  | 500  | 600  | 900  |
|---------------------|------|------|------|------|
| W/m 75/65/20 (φ50K) | 985  | 1181 | 1368 | 1880 |
| n-exponent          | 1,31 | 1,32 | 1,32 | 1,34 |
| Lengte (mm)         | Watt | Watt | Watt | Watt |
| 400                 |      |      |      | 752  |
| 500                 |      | 591  | 684  | 940  |
| 600                 | 591  | 709  | 821  | 1128 |
| 700                 |      | 827  | 958  | 1316 |
| 800                 | 788  | 945  | 1094 | 1504 |
| 900                 |      | 1063 | 1231 | 1692 |
| 1000                | 985  | 1181 | 1368 | 1880 |
| 1200                | 1182 | 1417 | 1642 |      |
| 1400                | 1379 | 1653 | 1915 |      |
| 1600                | 1576 | 1890 | 2189 |      |
| 1800                | 1773 | 2126 | 2462 |      |
| 2000                | 1970 | 2362 | 2736 |      |
| 2200                | 2167 | 2598 |      |      |
| 2400                | 2364 |      |      |      |
| 2800                | 2758 |      |      |      |

TYPE 21s Watts 70/55/20 conform EN442-1: 2014: radiatoren en convectoren

| Hoogte (mm)           | 400  | 500  | 600  | 900  |
|-----------------------|------|------|------|------|
| W/m 70/55/20 (φ42,5K) | 796  | 953  | 1104 | 1512 |
| n-exponent            | 1,31 | 1,32 | 1,32 | 1,34 |
| Lengte (mm)           | Watt | Watt | Watt | Watt |
| 400                   |      |      |      | 609  |
| 500                   |      | 476  | 552  | 756  |
| 600                   | 478  | 572  | 662  | 907  |
| 700                   |      | 667  | 773  | 1058 |
| 800                   | 637  | 762  | 883  | 1210 |
| 900                   |      | 858  | 993  | 1361 |
| 1000                  | 796  | 953  | 1104 | 1512 |
| 1200                  | 955  | 1144 | 1325 |      |
| 1400                  | 1115 | 1334 | 1545 |      |
| 1600                  | 1274 | 1525 | 1766 |      |
| 1800                  | 1433 | 1715 | 1987 |      |
| 2000                  | 1592 | 1906 | 2208 |      |
| 2200                  | 1751 | 2097 |      |      |
| 2400                  | 1911 |      |      |      |
| 2800                  | 2229 |      |      |      |

TYPE 21s Watts 55/45/20 conform EN442-1: 2014: radiatoren en convectoren

| Hoogte (mm)         | 400  | 500  | 600  | 900  |
|---------------------|------|------|------|------|
| W/m 55/45/20 (φ30K) | 504  | 602  | 697  | 948  |
| n-exponent          | 1,31 | 1,32 | 1,32 | 1,34 |
| Lengte (mm)         | Watt | Watt | Watt | Watt |
| 400                 |      |      |      | 387  |
| 500                 |      | 301  | 349  | 474  |
| 600                 | 303  | 361  | 418  | 569  |
| 700                 |      | 421  | 488  | 664  |
| 800                 | 404  | 481  | 558  | 759  |
| 900                 |      | 542  | 627  | 853  |
| 1000                | 504  | 602  | 697  | 948  |
| 1200                | 605  | 722  | 836  |      |
| 1400                | 706  | 842  | 976  |      |
| 1600                | 807  | 963  | 1115 |      |
| 1800                | 908  | 1083 | 1255 |      |
| 2000                | 1009 | 1203 | 1394 |      |
| 2200                | 1110 | 1324 |      |      |
| 2400                | 1211 |      |      |      |
| 2800                | 1412 |      |      |      |

# Casual

## STANDAARD



STANDAARD

TYPE 22 Watts 75/65/20 conform EN442-1: 2014: radiatoren en convectoren

| Hoogte (mm)         | 300  | 400  | 500  | 600  | 700  | 900  |
|---------------------|------|------|------|------|------|------|
| W/m 75/65/20 (φ50K) | 975  | 1241 | 1494 | 1738 | 1974 | 2429 |
| n-exponent          | 1,28 | 1,30 | 1,33 | 1,34 | 1,35 | 1,36 |
| Lengte (mm)         | Watt | Watt | Watt | Watt | Watt | Watt |
| 400                 |      |      | 598  | 695  | 790  | 972  |
| 500                 | 488  | 621  | 747  | 869  | 987  | 1215 |
| 600                 | 585  | 745  | 896  | 1043 | 1184 | 1457 |
| 700                 |      |      | 1046 | 1217 | 1382 | 1700 |
| 800                 | 780  | 993  | 1195 | 1390 | 1579 | 1943 |
| 900                 |      |      | 1345 | 1564 | 1777 | 2186 |
| 1000                | 975  | 1241 | 1494 | 1738 | 1974 | 2429 |
| 1100                |      |      | 1643 | 1912 |      |      |
| 1200                | 1170 | 1489 | 1793 | 2086 | 2369 | 2915 |
| 1400                | 1365 | 1737 | 2092 | 2433 |      |      |
| 1600                | 1560 | 1986 | 2390 | 2781 |      |      |
| 1800                | 1755 | 2234 | 2689 | 3128 |      |      |
| 2000                | 1950 | 2482 | 2988 | 3476 |      |      |
| 2200                | 2145 | 2730 | 3287 |      |      |      |
| 2400                | 2340 | 2978 | 3586 | 4171 |      |      |
| 2600                | 2535 | 3227 | 3884 | 4519 |      |      |
| 2800                | 2730 | 3475 | 4183 |      |      |      |
| 3000                |      | 3723 | 4482 |      |      |      |

TYPE 22 Watts 70/55/20 conform EN442-1: 2014: radiatoren en convectoren

| Hoogte (mm)           | 300  | 400  | 500  | 600  | 700  | 900  |
|-----------------------|------|------|------|------|------|------|
| W/m 70/55/20 (φ42,5K) | 792  | 1005 | 1204 | 1398 | 1585 | 1947 |
| n-exponent            | 1,28 | 1,30 | 1,33 | 1,34 | 1,35 | 1,36 |
| Lengte (mm)           | Watt | Watt | Watt | Watt | Watt | Watt |
| 400                   |      |      | 481  | 559  | 634  | 779  |
| 500                   | 396  | 502  | 602  | 699  | 793  | 974  |
| 600                   | 475  | 603  | 722  | 839  | 951  | 1168 |
| 700                   |      |      | 843  | 979  | 1110 | 1363 |
| 800                   | 634  | 804  | 963  | 1118 | 1268 | 1558 |
| 900                   |      |      | 1083 | 1258 | 1427 | 1753 |
| 1000                  | 792  | 1005 | 1204 | 1398 | 1585 | 1947 |
| 1100                  |      |      | 1324 | 1538 |      |      |
| 1200                  | 950  | 1206 | 1444 | 1677 | 1902 | 2337 |
| 1400                  | 1109 | 1407 | 1685 | 1957 |      |      |
| 1600                  | 1267 | 1607 | 1926 | 2237 |      |      |
| 1800                  | 1425 | 1808 | 2166 | 2516 |      |      |
| 2000                  | 1584 | 2009 | 2407 | 2796 |      |      |
| 2200                  | 1742 | 2210 | 2648 |      |      |      |
| 2400                  | 1901 | 2411 | 2889 | 3355 |      |      |
| 2600                  | 2059 | 2612 | 3129 | 3634 |      |      |
| 2800                  | 2217 | 2813 | 3370 |      |      |      |
| 3000                  |      | 3014 | 3611 |      |      |      |

## TYPE 22

Watts 55/45/20 conform EN442-1: 2014: radiatoren en convectoren

## STANDAARD

| Hoogte (mm)         | 300  | 400  | 500  | 600  | 700  | 900  |
|---------------------|------|------|------|------|------|------|
| W/m 55/45/20 (φ30K) | 507  | 639  | 757  | 877  | 990  | 1213 |
| n-exponent          | 1,28 | 1,30 | 1,33 | 1,34 | 1,35 | 1,36 |
| Lengte (mm)         | Watt | Watt | Watt | Watt | Watt | Watt |
| 400                 |      |      | 303  | 351  | 396  | 485  |
| 500                 | 254  | 319  | 379  | 438  | 495  | 606  |
| 600                 | 304  | 383  | 454  | 526  | 594  | 728  |
| 700                 |      |      | 530  | 614  | 693  | 849  |
| 800                 | 406  | 511  | 606  | 701  | 792  | 970  |
| 900                 |      |      | 682  | 789  | 891  | 1091 |
| 1000                | 507  | 639  | 757  | 877  | 990  | 1213 |
| 1100                |      |      | 833  | 964  |      |      |
| 1200                | 608  | 767  | 909  | 1052 | 1189 | 1455 |
| 1400                | 710  | 894  | 1060 | 1227 |      |      |
| 1600                | 811  | 1022 | 1212 | 1402 |      |      |
| 1800                | 913  | 1150 | 1363 | 1578 |      |      |
| 2000                | 1014 | 1278 | 1515 | 1753 |      |      |
| 2200                | 1115 | 1405 | 1666 |      |      |      |
| 2400                | 1217 | 1533 | 1818 | 2104 |      |      |
| 2600                | 1318 | 1661 | 1969 | 2279 |      |      |
| 2800                | 1420 | 1789 | 2121 |      |      |      |
| 3000                |      | 1916 | 2272 |      |      |      |

STANDAARD

TYPE 33 Watts 75/65/20 conform EN442-1: 2014: radiatoren en convectoren

| Hoogte (mm)         | 300  | 400  | 500  | 600  | 700  | 900  |
|---------------------|------|------|------|------|------|------|
| W/m 75/65/20 (φ50K) | 1365 | 1744 | 2103 | 2444 | 2769 | 3376 |
| n-exponent          | 1,28 | 1,32 | 1,33 | 1,33 | 1,33 | 1,34 |
| Lengte (mm)         | Watt | Watt | Watt | Watt | Watt | Watt |
| 500                 |      |      | 1052 |      | 1385 | 1688 |
| 600                 |      |      | 1262 | 1466 |      | 2026 |
| 700                 |      |      | 1472 |      | 1938 | 2363 |
| 800                 | 1092 | 1395 | 1682 | 1955 |      | 2701 |
| 1000                |      | 1744 | 2103 | 2444 | 2769 | 3376 |
| 1200                |      | 2093 | 2524 | 2933 |      | 4051 |
| 1400                | 1911 | 2442 | 2944 | 3422 |      |      |
| 1600                | 2184 | 2790 | 3365 | 3910 |      |      |
| 1800                | 2457 | 3139 | 3785 | 4399 |      |      |
| 2000                | 2730 | 3488 | 4206 | 4888 |      |      |
| 2200                | 3003 | 3837 |      |      |      |      |
| 2400                | 3276 | 4186 |      |      |      |      |
| 2600                |      | 4534 |      |      |      |      |
| 2800                | 3822 | 4883 |      |      |      |      |
| 3000                |      | 5232 |      |      |      |      |

TYPE 33 Watts 70/55/20 conform EN442-1: 2014: radiatoren en convectoren

| Hoogte (mm)           | 300  | 400  | 500  | 600  | 700  | 900  |
|-----------------------|------|------|------|------|------|------|
| W/m 70/55/20 (φ42,5K) | 1105 | 1412 | 1702 | 1979 | 2242 | 2733 |
| n-exponent            | 1,28 | 1,32 | 1,33 | 1,33 | 1,33 | 1,34 |
| Lengte (mm)           | Watt | Watt | Watt | Watt | Watt | Watt |
| 500                   |      |      | 852  |      | 1121 | 1367 |
| 600                   |      |      | 1022 | 1187 |      | 1640 |
| 700                   |      |      | 1192 |      | 1569 | 1913 |
| 800                   | 884  | 1129 | 1362 | 1583 |      | 2187 |
| 1000                  |      | 1412 | 1702 | 1979 | 2242 | 2733 |
| 1200                  |      | 1694 | 2043 | 2374 |      | 3279 |
| 1400                  | 1547 | 1977 | 2383 | 2770 |      |      |
| 1600                  | 1768 | 2259 | 2724 | 3156 |      |      |
| 1800                  | 1989 | 2541 | 3064 | 3561 |      |      |
| 2000                  | 2210 | 2824 | 3405 | 3957 |      |      |
| 2200                  | 2431 | 3106 |      |      |      |      |
| 2400                  | 2652 | 3389 |      |      |      |      |
| 2600                  |      | 3671 |      |      |      |      |
| 2800                  | 3094 | 3953 |      |      |      |      |
| 3000                  |      | 4236 |      |      |      |      |



## STANDAARD

**TYPE 33** Watts 55/45/20 conform EN442-1: 2014: radiatoren en convectoren

| Hoogte (mm)         | 300  | 400  | 500  | 600  | 700  | 900  |
|---------------------|------|------|------|------|------|------|
| W/m 55/45/20 (φ30K) | 703  | 898  | 1083 | 1258 | 1425 | 1738 |
| n-exponent          | 1,28 | 1,32 | 1,33 | 1,33 | 1,33 | 1,34 |
| Lengte (mm)         | Watt | Watt | Watt | Watt | Watt | Watt |
| 500                 |      |      | 542  |      | 713  | 869  |
| 600                 |      |      | 650  | 755  |      | 1043 |
| 700                 |      |      | 758  |      | 998  | 1216 |
| 800                 | 562  | 718  | 866  | 1006 |      | 1390 |
| 1000                |      | 898  | 1083 | 1258 | 1425 | 1738 |
| 1200                |      | 1077 | 1299 | 1510 |      | 2085 |
| 1400                | 984  | 1257 | 1515 | 1761 |      |      |
| 1600                | 1124 | 1436 | 1732 | 2013 |      |      |
| 1800                | 1265 | 1616 | 1948 | 2264 |      |      |
| 2000                | 1405 | 1795 | 2165 | 2516 |      |      |
| 2200                | 1546 | 1975 |      |      |      |      |
| 2400                | 1686 | 2155 |      |      |      |      |
| 2600                |      | 2334 |      |      |      |      |
| 2800                | 1967 | 2514 |      |      |      |      |
| 3000                |      | 2693 |      |      |      |      |

Kompakt



TYPE 11 Watts 75/65/20 conform EN442-1: 2014: radiatoren en convectoren

| Hoogte (mm)         | 400  | 500  | 600  | 700  | 900  |
|---------------------|------|------|------|------|------|
| W/m 75/65/20 (φ50K) | 697  | 840  | 979  | 1117 | 1390 |
| n-exponent          | 1,24 | 1,25 | 1,27 | 1,28 | 1,30 |
| Lengte (mm)         | Watt | Watt | Watt | Watt | Watt |
| 400                 | 279  | 336  | 392  | 447  | 556  |
| 500                 |      | 420  | 490  | 559  | 695  |
| 600                 | 418  | 504  | 587  | 670  | 834  |
| 700                 |      | 588  | 685  | 782  | 973  |
| 800                 | 558  | 672  | 783  | 894  | 1112 |
| 900                 |      | 756  | 881  | 1005 | 1251 |
| 1000                | 697  | 840  | 979  | 1117 | 1390 |
| 1100                |      | 924  | 1077 |      |      |
| 1200                | 836  | 1008 | 1175 | 1340 | 1668 |
| 1400                | 976  | 1176 | 1371 |      |      |
| 1600                |      | 1344 | 1567 |      |      |
| 1800                | 1255 | 1512 | 1762 |      |      |
| 2000                | 1394 | 1680 | 1958 |      |      |

TYPE 11 Watts 70/55/20 conform EN442-1: 2014: radiatoren en convectoren

| Hoogte (mm)           | 400  | 500  | 600  | 700  | 900  |
|-----------------------|------|------|------|------|------|
| W/m 70/55/20 (φ42,5K) | 565  | 679  | 789  | 899  | 1114 |
| n-exponent            | 1,24 | 1,25 | 1,27 | 1,28 | 1,30 |
| Lengte (mm)           | Watt | Watt | Watt | Watt | Watt |
| 400                   | 226  | 272  | 316  | 359  | 446  |
| 500                   |      | 339  | 394  | 449  | 557  |
| 600                   | 339  | 407  | 473  | 539  | 668  |
| 700                   |      | 475  | 552  | 629  | 780  |
| 800                   | 452  | 543  | 631  | 719  | 891  |
| 900                   |      | 611  | 710  | 809  | 1003 |
| 1000                  | 565  | 679  | 789  | 899  | 1114 |
| 1100                  |      | 747  | 868  |      |      |
| 1200                  | 678  | 815  | 947  | 1078 | 1337 |
| 1400                  | 791  | 951  | 1105 |      |      |
| 1600                  |      | 1086 | 1262 |      |      |
| 1800                  | 1017 | 1222 | 1420 |      |      |
| 2000                  | 1130 | 1358 | 1578 |      |      |

TYPE 11 Watts 55/45/20 conform EN442-1: 2014: radiatoren en convectoren

| Hoogte (mm)         | 400  | 500  | 600  | 700  | 900  |
|---------------------|------|------|------|------|------|
| W/m 55/45/20 (φ30K) | 368  | 439  | 507  | 576  | 708  |
| n-exponent          | 1,24 | 1,25 | 1,27 | 1,28 | 1,30 |
| Lengte (mm)         | Watt | Watt | Watt | Watt | Watt |
| 400                 | 147  | 176  | 203  | 230  | 283  |
| 500                 |      | 220  | 254  | 288  | 354  |
| 600                 | 221  | 264  | 304  | 345  | 425  |
| 700                 |      | 307  | 355  | 403  | 496  |
| 800                 | 294  | 351  | 406  | 460  | 567  |
| 900                 |      | 395  | 457  | 518  | 638  |
| 1000                | 368  | 439  | 507  | 576  | 708  |
| 1100                |      | 483  | 558  |      |      |
| 1200                | 441  | 527  | 609  | 691  | 850  |
| 1400                | 515  | 615  | 710  |      |      |
| 1600                |      | 703  | 812  |      |      |
| 1800                | 662  | 791  | 913  |      |      |
| 2000                | 736  | 878  | 1015 |      |      |

KOMPAKT

TYPE 21s Watts 75/65/20 conform EN442-1: 2014: radiatoren en convectoren

| Hoogte (mm)         | 400  | 500  | 600  | 700  | 900  |
|---------------------|------|------|------|------|------|
| W/m 75/65/20 (φ50K) | 953  | 1141 | 1322 | 1499 | 1841 |
| n-exponent          | 1,31 | 1,32 | 1,32 | 1,32 | 1,33 |
| Lengte (mm)         | Watt | Watt | Watt | Watt | Watt |
| 400                 |      | 456  | 529  | 600  | 737  |
| 500                 | 476  | 571  | 661  | 750  | 921  |
| 600                 | 572  | 685  | 793  | 899  | 1105 |
| 700                 |      | 799  | 925  | 1049 | 1289 |
| 800                 | 762  | 913  | 1058 | 1199 | 1473 |
| 900                 |      | 1027 | 1190 | 1349 | 1657 |
| 1000                | 953  | 1141 | 1322 | 1499 | 1841 |
| 1200                | 1144 | 1369 | 1586 | 1799 | 2209 |
| 1400                | 1334 | 1597 | 1851 | 2099 | 2577 |
| 1600                | 1525 | 1826 | 2115 | 2398 | 2946 |
| 1800                | 1715 | 2054 | 2380 | 2698 | 3314 |
| 2000                | 1906 | 2282 | 2644 | 2998 | 3682 |
| 2200                | 2097 | 2510 | 2908 |      |      |
| 2400                | 2287 | 2738 | 3173 |      |      |
| 2600                |      |      |      |      |      |
| 2800                |      |      |      |      |      |
| 3000                |      |      |      |      |      |

TYPE 21s Watts 70/55/20 conform EN442-1: 2014: radiatoren en convectoren

| Hoogte (mm)           | 400  | 500  | 600  | 700  | 900  |
|-----------------------|------|------|------|------|------|
| W/m 70/55/20 (φ42,5K) | 770  | 921  | 1067 | 1210 | 1483 |
| n-exponent            | 1,31 | 1,32 | 1,32 | 1,32 | 1,33 |
| Lengte (mm)           | Watt | Watt | Watt | Watt | Watt |
| 400                   |      | 368  | 427  | 484  | 593  |
| 500                   | 385  | 460  | 533  | 605  | 742  |
| 600                   | 462  | 552  | 640  | 726  | 890  |
| 700                   |      | 644  | 747  | 847  | 1038 |
| 800                   | 616  | 737  | 853  | 968  | 1187 |
| 900                   |      | 829  | 960  | 1089 | 1335 |
| 1000                  | 770  | 921  | 1067 | 1210 | 1483 |
| 1200                  | 924  | 1105 | 1280 | 1451 | 1780 |
| 1400                  | 1078 | 1289 | 1493 | 1693 | 2076 |
| 1600                  | 1232 | 1473 | 1707 | 1935 | 2373 |
| 1800                  | 1386 | 1657 | 1920 | 2177 | 2670 |
| 2000                  | 1540 | 1841 | 2134 | 2419 | 2966 |
| 2200                  | 1695 | 2026 | 2347 |      |      |
| 2400                  | 1849 | 2210 | 2560 |      |      |
| 2600                  |      |      |      |      |      |
| 2800                  |      |      |      |      |      |
| 3000                  |      |      |      |      |      |

TYPE 21s Watts 55/45/20 conform EN442-1: 2014: radiatoren en convectoren

| Hoogte (mm)         | 400  | 500  | 600  | 700  | 900  |
|---------------------|------|------|------|------|------|
| W/m 55/45/20 (φ30K) | 488  | 581  | 674  | 764  | 933  |
| n-exponent          | 1,31 | 1,32 | 1,32 | 1,32 | 1,33 |
| Lengte (mm)         | Watt | Watt | Watt | Watt | Watt |
| 400                 |      | 233  | 269  | 306  | 373  |
| 500                 | 244  | 291  | 337  | 382  | 467  |
| 600                 | 293  | 349  | 404  | 458  | 560  |
| 700                 |      | 407  | 472  | 535  | 653  |
| 800                 | 390  | 465  | 539  | 611  | 747  |
| 900                 |      | 523  | 606  | 687  | 840  |
| 1000                | 488  | 581  | 674  | 764  | 933  |
| 1200                | 586  | 698  | 808  | 917  | 1120 |
| 1400                | 683  | 814  | 943  | 1069 | 1307 |
| 1600                | 781  | 930  | 1078 | 1222 | 1493 |
| 1800                | 879  | 1046 | 1212 | 1375 | 1680 |
| 2000                | 976  | 1163 | 1347 | 1528 | 1866 |
| 2200                | 1074 | 1279 | 1482 |      |      |
| 2400                | 1171 | 1395 | 1617 |      |      |
| 2600                |      |      |      |      |      |
| 2800                |      |      |      |      |      |
| 3000                |      |      |      |      |      |

KOMPAKT

TYPE 22 Watts 75/65/20 conform EN442-1: 2014: radiatoren en convectoren

| Hoogte (mm)         | 300  | 400  | 500  | 600  | 700  | 900  |
|---------------------|------|------|------|------|------|------|
| W/m 75/65/20 (φ50K) | 942  | 1202 | 1449 | 1683 | 1907 | 2326 |
| n-exponent          | 1,31 | 1,32 | 1,32 | 1,33 | 1,33 | 1,34 |
| Lengte (mm)         | Watt | Watt | Watt | Watt | Watt | Watt |
| 400                 |      |      | 580  | 673  | 763  | 930  |
| 500                 | 471  | 601  | 725  | 842  | 954  | 1163 |
| 600                 | 565  | 721  | 869  | 1010 | 1144 | 1396 |
| 700                 |      |      | 1014 | 1178 | 1335 | 1628 |
| 800                 | 754  | 962  | 1159 | 1346 | 1526 | 1861 |
| 900                 |      |      | 1304 | 1515 | 1716 | 2093 |
| 1000                | 942  | 1202 | 1449 | 1683 | 1907 | 2326 |
| 1100                |      |      | 1594 | 1851 | 2098 | 2559 |
| 1200                | 1130 | 1442 | 1739 | 2020 | 2288 | 2791 |
| 1300                | 1225 | 1563 | 1884 | 2188 | 2479 | 3024 |
| 1400                | 1319 | 1683 | 2029 | 2356 | 2670 | 3256 |
| 1600                | 1507 | 1923 | 2318 | 2693 | 3051 | 3722 |
| 1800                | 1696 | 2164 | 2608 | 3029 | 3433 | 4187 |
| 2000                | 1884 | 2404 | 2898 | 3366 | 3814 | 4652 |
| 2200                | 2072 | 2644 | 3188 | 3703 |      |      |
| 2400                | 2261 | 2885 | 3478 | 4039 |      |      |
| 2600                | 2449 | 3125 | 3767 | 4376 |      |      |
| 2800                | 2638 | 3366 | 4057 | 4712 |      |      |
| 3000                | 2826 | 3606 | 4347 | 5049 |      |      |

TYPE 22 Watts 70/55/20 conform EN442-1: 2014: radiatoren en convectoren

| Hoogte (mm)           | 300  | 400  | 500  | 600  | 700  | 900  |
|-----------------------|------|------|------|------|------|------|
| W/m 70/55/20 (φ42,5K) | 761  | 970  | 1169 | 1356 | 1536 | 1871 |
| n-exponent            | 1,31 | 1,32 | 1,32 | 1,33 | 1,33 | 1,34 |
| Lengte (mm)           | Watt | Watt | Watt | Watt | Watt | Watt |
| 400                   |      |      | 468  | 542  | 615  | 748  |
| 500                   | 381  | 485  | 585  | 678  | 768  | 935  |
| 600                   | 457  | 582  | 702  | 814  | 922  | 1122 |
| 700                   |      |      | 818  | 949  | 1075 | 1310 |
| 800                   | 609  | 776  | 935  | 1085 | 1229 | 1497 |
| 900                   |      |      | 1052 | 1220 | 1383 | 1684 |
| 1000                  | 761  | 970  | 1169 | 1356 | 1536 | 1871 |
| 1100                  |      |      | 1286 | 1491 | 1690 | 2058 |
| 1200                  | 914  | 1164 | 1403 | 1627 | 1844 | 2245 |
| 1300                  | 990  | 1261 | 1520 | 1763 | 1997 | 2432 |
| 1400                  | 1066 | 1358 | 1637 | 1898 | 2151 | 2619 |
| 1600                  | 1218 | 1552 | 1871 | 2169 | 2458 | 2993 |
| 1800                  | 1370 | 1746 | 2105 | 2441 | 2765 | 3367 |
| 2000                  | 1523 | 1940 | 2338 | 2712 | 3073 | 3742 |
| 2200                  | 1675 | 2134 | 2572 | 2983 |      |      |
| 2400                  | 1827 | 2328 | 2806 | 3254 |      |      |
| 2600                  | 1980 | 2522 | 3040 | 3525 |      |      |
| 2800                  | 2132 | 2716 | 3274 | 3796 |      |      |
| 3000                  | 2284 | 2910 | 3508 | 4068 |      |      |

## TYPE 22

Watts 55/45/20 conform EN442-1: 2014: radiatoren en convectoren

## KOMPAKT

| Hoogte (mm)         | 300  | 400  | 500  | 600  | 700  | 900  |
|---------------------|------|------|------|------|------|------|
| W/m 55/45/20 (φ30K) | 482  | 612  | 738  | 853  | 967  | 1173 |
| n-exponent          | 1,31 | 1,32 | 1,32 | 1,33 | 1,33 | 1,34 |
| Lengte (mm)         | Watt | Watt | Watt | Watt | Watt | Watt |
| 400                 |      |      | 295  | 341  | 387  | 469  |
| 500                 | 241  | 306  | 369  | 427  | 483  | 587  |
| 600                 | 289  | 367  | 443  | 512  | 580  | 704  |
| 700                 |      |      | 517  | 597  | 677  | 821  |
| 800                 | 386  | 490  | 591  | 683  | 773  | 938  |
| 900                 |      |      | 664  | 768  | 870  | 1056 |
| 1000                | 482  | 612  | 738  | 853  | 967  | 1173 |
| 1100                |      |      | 812  | 938  | 1063 | 1290 |
| 1200                | 579  | 735  | 886  | 1024 | 1160 | 1408 |
| 1300                | 627  | 796  | 960  | 1109 | 1257 | 1525 |
| 1400                | 675  | 857  | 1034 | 1194 | 1353 | 1642 |
| 1600                | 772  | 980  | 1181 | 1365 | 1547 | 1877 |
| 1800                | 868  | 1102 | 1329 | 1536 | 1740 | 2112 |
| 2000                | 965  | 1225 | 1477 | 1706 | 1933 | 2346 |
| 2200                | 1061 | 1347 | 1624 | 1877 |      |      |
| 2400                | 1158 | 1470 | 1772 | 2048 |      |      |
| 2600                | 1254 | 1592 | 1920 | 2218 |      |      |
| 2800                | 1351 | 1715 | 2067 | 2389 |      |      |
| 3000                | 1447 | 1837 | 2215 | 2559 |      |      |

Kompakt

TYPE 33 Watts 75/65/20 conform EN442-1: 2014: radiatoren en convectoren

| Hoogte (mm)         | 300  | 400  | 500  | 600  | 700  | 900  |
|---------------------|------|------|------|------|------|------|
| W/m 75/65/20 (φ50K) | 1319 | 1679 | 2020 | 2345 | 2657 | 3248 |
| n-exponent          | 1,32 | 1,32 | 1,32 | 1,32 | 1,33 | 1,36 |
| Lengte (mm)         | Watt | Watt | Watt | Watt | Watt | Watt |
| 400                 |      |      |      |      | 1063 | 1299 |
| 500                 |      |      |      |      | 1329 | 1624 |
| 600                 |      | 1007 | 1212 | 1407 | 1594 | 1949 |
| 700                 |      |      | 1414 | 1642 |      | 2274 |
| 800                 | 1055 | 1343 | 1616 | 1876 | 2126 | 2598 |
| 900                 |      |      | 1818 | 2111 | 2391 | 2923 |
| 1000                | 1319 | 1679 | 2020 | 2345 | 2657 | 3248 |
| 1100                |      |      |      |      |      |      |
| 1200                | 1583 | 2015 | 2424 | 2814 | 3188 | 3898 |
| 1300                |      |      |      |      |      |      |
| 1400                | 1847 | 2351 | 2828 | 3283 | 3720 | 4547 |
| 1600                | 2110 | 2686 | 3232 | 3752 | 4251 | 5197 |
| 1800                | 2374 | 3022 | 3636 | 4221 | 4783 | 5846 |
| 2000                | 2638 | 3358 | 4040 | 4690 | 5314 | 6496 |
| 2200                | 2902 | 3694 | 4444 | 5159 |      |      |
| 2400                | 3166 | 4030 | 4848 | 5628 |      |      |
| 2600                | 3429 | 4365 | 5252 | 6097 |      |      |
| 2800                | 3693 | 4701 | 5656 | 6566 |      |      |
| 3000                | 3957 | 5037 | 6060 | 7035 |      |      |

TYPE 33 Watts 70/55/20 conform EN442-1: 2014: radiatoren en convectoren

| Hoogte (mm)           | 300  | 400  | 500  | 600  | 700  | 900  |
|-----------------------|------|------|------|------|------|------|
| W/m 70/55/20 (φ42,5K) | 1068 | 1359 | 1635 | 1898 | 2151 | 2629 |
| n-exponent            | 1,32 | 1,32 | 1,32 | 1,32 | 1,33 | 1,36 |
| Lengte (mm)           | Watt | Watt | Watt | Watt | Watt | Watt |
| 400                   |      |      |      |      | 861  | 1052 |
| 500                   |      |      |      |      | 1076 | 1315 |
| 600                   |      | 815  | 981  | 1139 | 1290 | 1578 |
| 700                   |      |      | 1145 | 1329 |      | 1841 |
| 800                   | 854  | 1087 | 1308 | 1519 | 1721 | 2103 |
| 900                   |      |      | 1472 | 1709 | 1936 | 2366 |
| 1000                  | 1068 | 1359 | 1635 | 1898 | 2151 | 2629 |
| 1100                  |      |      |      |      |      |      |
| 1200                  | 1282 | 1631 | 1962 | 2278 | 2581 | 3156 |
| 1300                  |      |      |      |      |      |      |
| 1400                  | 1495 | 1903 | 2289 | 2658 | 3012 | 3681 |
| 1600                  | 1708 | 2174 | 2616 | 3037 | 3441 | 4207 |
| 1800                  | 1922 | 2446 | 2944 | 3417 | 3872 | 4733 |
| 2000                  | 2136 | 2718 | 3271 | 3797 | 4302 | 5259 |
| 2200                  | 2349 | 2990 | 3598 | 4176 |      |      |
| 2400                  | 2563 | 3262 | 3925 | 4556 |      |      |
| 2600                  | 2776 | 3534 | 4252 | 4936 |      |      |
| 2800                  | 2990 | 3806 | 4579 | 5316 |      |      |
| 3000                  | 3203 | 4078 | 4906 | 5695 |      |      |

## TYPE 33

Watts 55/45/20 conform EN442-1: 2014: radiatoren en convectoren

## KOMPAKT

| Hoogte (mm)         | 300  | 400  | 500  | 600  | 700  | 900  |
|---------------------|------|------|------|------|------|------|
| W/m 55/45/20 (φ30K) | 679  | 864  | 1040 | 1207 | 1368 | 1672 |
| n-exponent          | 1,32 | 1,32 | 1,32 | 1,32 | 1,33 | 1,36 |
| Lengte (mm)         | Watt | Watt | Watt | Watt | Watt | Watt |
| 400                 |      |      |      |      | 547  | 669  |
| 500                 |      |      |      |      | 684  | 836  |
| 600                 |      | 518  | 624  | 724  | 821  | 1003 |
| 700                 |      |      | 728  | 845  |      | 1171 |
| 800                 | 543  | 691  | 832  | 966  | 1094 | 1337 |
| 900                 |      |      | 936  | 1087 | 1231 | 1505 |
| 1000                | 679  | 864  | 1040 | 1207 | 1368 | 1672 |
| 1100                |      |      |      |      |      |      |
| 1200                | 815  | 1037 | 1248 | 1449 | 1641 | 2006 |
| 1300                |      |      |      |      |      |      |
| 1400                | 951  | 1210 | 1456 | 1690 | 1915 | 2341 |
| 1600                | 1086 | 1383 | 1664 | 1931 | 2188 | 2675 |
| 1800                | 1222 | 1556 | 1872 | 2173 | 2462 | 3009 |
| 2000                | 1358 | 1729 | 2080 | 2414 | 2735 | 3344 |
| 2200                | 1494 | 1901 | 2288 | 2656 |      |      |
| 2400                | 1630 | 2074 | 2496 | 2897 |      |      |
| 2600                | 1765 | 2247 | 2703 | 3138 |      |      |
| 2800                | 1901 | 2420 | 2911 | 3380 |      |      |
| 3000                | 2037 | 2593 | 3119 | 3621 |      |      |

**SUPER 6  
UNIVERSEEL**



**TYPE 11** Watts 75/65/20 conform EN442-1: 2014: radiatoren en convectoren

| Hoogte (mm)         | 400  | 500  | 600  | 700  | 900  |
|---------------------|------|------|------|------|------|
| W/m 75/65/20 (φ50K) | 697  | 840  | 979  | 1117 | 1390 |
| n-exponent          | 1,24 | 1,25 | 1,27 | 1,28 | 1,30 |
| Lengte (mm)         | Watt | Watt | Watt | Watt | Watt |
| 400                 | 279  | 336  | 392  | 447  | 556  |
| 600                 | 418  | 504  | 587  | 670  | 834  |
| 700                 | 488  | 588  | 685  | 782  | 973  |
| 800                 | 558  | 672  | 783  | 894  | 1112 |
| 900                 | 627  | 756  | 881  | 1005 | 1251 |
| 1000                | 697  | 840  | 979  | 1117 | 1390 |
| 1200                | 836  | 1008 | 1175 | 1340 | 1668 |
| 1400                | 976  | 1176 | 1371 | 1564 | 1946 |
| 1600                | 1115 | 1344 | 1567 | 1787 | 2224 |
| 1800                | 1255 | 1512 | 1762 | 2011 | 2502 |
| 2000                | 1394 | 1680 | 1958 | 2234 | 2780 |

**TYPE 11** Watts 70/55/20 conform EN442-1: 2014: radiatoren en convectoren

| Hoogte (mm)           | 400  | 500  | 600  | 700  | 900  |
|-----------------------|------|------|------|------|------|
| W/m 70/55/20 (φ42,5K) | 565  | 679  | 789  | 899  | 1114 |
| n-exponent            | 1,24 | 1,25 | 1,27 | 1,28 | 1,30 |
| Lengte (mm)           | Watt | Watt | Watt | Watt | Watt |
| 400                   | 226  | 272  | 316  | 359  | 446  |
| 600                   | 339  | 407  | 473  | 539  | 668  |
| 700                   | 396  | 475  | 552  | 629  | 780  |
| 800                   | 452  | 543  | 631  | 719  | 891  |
| 900                   | 509  | 611  | 710  | 809  | 1003 |
| 1000                  | 565  | 679  | 789  | 899  | 1114 |
| 1200                  | 678  | 815  | 947  | 1078 | 1337 |
| 1400                  | 791  | 951  | 1105 | 1258 | 1560 |
| 1600                  | 904  | 1086 | 1262 | 1438 | 1783 |
| 1800                  | 1017 | 1222 | 1420 | 1617 | 2005 |
| 2000                  | 1130 | 1358 | 1578 | 1797 | 2228 |

**TYPE 11** Watts 55/45/20 conform EN442-1: 2014: radiatoren en convectoren

| Hoogte (mm)         | 400  | 500  | 600  | 700  | 900  |
|---------------------|------|------|------|------|------|
| W/m 55/45/20 (φ30K) | 368  | 439  | 507  | 576  | 708  |
| n-exponent          | 1,24 | 1,25 | 1,27 | 1,28 | 1,30 |
| Lengte (mm)         | Watt | Watt | Watt | Watt | Watt |
| 400                 | 147  | 176  | 203  | 230  | 283  |
| 600                 | 221  | 264  | 304  | 345  | 425  |
| 700                 | 257  | 307  | 355  | 403  | 496  |
| 800                 | 294  | 351  | 406  | 460  | 567  |
| 900                 | 331  | 395  | 457  | 518  | 638  |
| 1000                | 368  | 439  | 507  | 576  | 708  |
| 1200                | 441  | 527  | 609  | 691  | 850  |
| 1400                | 515  | 615  | 710  | 806  | 992  |
| 1600                | 588  | 703  | 812  | 921  | 1133 |
| 1800                | 662  | 791  | 913  | 1036 | 1275 |
| 2000                | 736  | 878  | 1015 | 1151 | 1417 |



**SUPER 6  
UNIVERSEEL**

**TYPE 20s** Watts 75/65/20 conform EN442-1: 2014: radiatoren en convectoren

| Hoogte (mm)         | 400  | 500  | 600  | 700  | 900  |
|---------------------|------|------|------|------|------|
| W/m 75/65/20 (φ50K) | 740  | 884  | 1026 | 1166 | 1446 |
| n-exponent          | 1,29 | 1,30 | 1,30 | 1,31 | 1,32 |
| Lengte (mm)         | Watt | Watt | Watt | Watt | Watt |
| 500                 | 370  | 442  | 513  | 583  | 723  |
| 600                 | 444  | 530  | 616  | 700  | 868  |
| 700                 |      | 619  | 718  | 816  | 1012 |
| 800                 | 592  | 707  | 821  | 933  | 1157 |
| 900                 |      | 796  | 923  | 1049 | 1301 |
| 1000                | 740  | 884  | 1026 | 1166 |      |
| 1100                |      | 972  | 1129 | 1283 |      |
| 1200                | 888  | 1061 | 1231 | 1399 | 1735 |
| 1400                | 1036 | 1238 | 1436 | 1632 | 2024 |
| 1600                | 1184 | 1414 | 1642 | 1866 | 2314 |
| 1800                | 1332 | 1591 | 1847 | 2099 | 2603 |
| 2000                | 1480 | 1768 | 2052 | 2332 | 2892 |
| 2200                | 1628 | 1945 | 2257 |      |      |
| 2400                | 1776 | 2122 | 2462 |      |      |
| 2600                | 1924 | 2298 | 2668 |      |      |
| 2800                | 2072 | 2475 | 2873 |      |      |
| 3000                | 2220 | 2652 | 3078 |      |      |

**TYPE 20s** Watts 70/55/20 conform EN442-1: 2014: radiatoren en convectoren

| Hoogte (mm)           | 400  | 500  | 600  | 700  | 900  |
|-----------------------|------|------|------|------|------|
| W/m 70/55/20 (φ42,5K) | 600  | 716  | 831  | 942  | 1167 |
| n-exponent            | 1,29 | 1,30 | 1,30 | 1,31 | 1,32 |
| Lengte (mm)           | Watt | Watt | Watt | Watt | Watt |
| 500                   | 300  | 358  | 415  | 471  | 583  |
| 600                   | 360  | 429  | 498  | 565  | 700  |
| 700                   |      | 501  | 581  | 660  | 817  |
| 800                   | 480  | 573  | 664  | 754  | 933  |
| 900                   |      | 644  | 748  | 848  | 1050 |
| 1000                  | 600  | 716  | 831  | 942  |      |
| 1100                  |      | 787  | 914  | 1037 |      |
| 1200                  | 720  | 859  | 997  | 1131 | 1400 |
| 1400                  | 840  | 1002 | 1163 | 1319 | 1634 |
| 1600                  | 960  | 1145 | 1329 | 1508 | 1867 |
| 1800                  | 1080 | 1288 | 1495 | 1696 | 2100 |
| 2000                  | 1200 | 1431 | 1661 | 1885 | 2334 |
| 2200                  | 1320 | 1574 | 1827 |      |      |
| 2400                  | 1440 | 1718 | 1993 |      |      |
| 2600                  | 1560 | 1861 | 2160 |      |      |
| 2800                  | 1680 | 2004 | 2326 |      |      |
| 3000                  | 1800 | 2147 | 2492 |      |      |

**TYPE 20s** Watts 55/45/20 conform EN442-1: 2014: radiatoren en convectoren

| Hoogte (mm)         | 400  | 500  | 600  | 700  | 900  |
|---------------------|------|------|------|------|------|
| W/m 55/45/20 (φ30K) | 383  | 455  | 528  | 597  | 737  |
| n-exponent          | 1,29 | 1,30 | 1,30 | 1,31 | 1,32 |
| Lengte (mm)         | Watt | Watt | Watt | Watt | Watt |
| 500                 | 191  | 228  | 264  | 299  | 368  |
| 600                 | 230  | 273  | 317  | 358  | 442  |
| 700                 |      | 319  | 370  | 418  | 516  |
| 800                 | 306  | 364  | 423  | 478  | 589  |
| 900                 |      | 410  | 475  | 537  | 663  |
| 1000                | 383  | 455  | 528  | 597  |      |
| 1100                |      | 501  | 581  | 657  |      |
| 1200                | 459  | 546  | 634  | 717  | 884  |
| 1400                | 536  | 637  | 739  | 836  | 1031 |
| 1600                | 689  | 819  | 951  | 1075 | 1326 |
| 1800                | 766  | 910  | 1056 | 1194 | 1474 |
| 2000                | 842  | 1001 | 1162 | 1314 | 1621 |
| 2200                | 919  | 1092 | 1268 |      |      |
| 2400                | 995  | 1183 | 1373 |      |      |
| 2600                | 1034 | 1229 | 1426 |      |      |
| 2800                | 1072 | 1274 | 1479 |      |      |
| 3000                | 1149 | 1365 | 1584 |      |      |

**SUPER 6  
UNIVERSEEL**

**TYPE 21s** Watts 75/65/20 conform EN442-1: 2014: radiatoren en convectoren

| Hoogte (mm)         | 400  | 500  | 600  | 700  | 900  |
|---------------------|------|------|------|------|------|
| W/m 75/65/20 (φ50K) | 953  | 1141 | 1322 | 1499 | 1841 |
| n-exponent          | 1,31 | 1,32 | 1,32 | 1,32 | 1,33 |
| Lengte (mm)         | Watt | Watt | Watt | Watt | Watt |
| 400                 | 381  | 456  | 529  | 600  | 736  |
| 500                 | 477  | 571  | 661  | 750  | 921  |
| 600                 | 572  | 685  | 793  | 899  | 1105 |
| 700                 | 667  | 799  | 925  | 1049 | 1289 |
| 800                 | 762  | 913  | 1058 | 1199 | 1473 |
| 900                 | 858  | 1027 | 1190 | 1349 | 1657 |
| 1000                | 953  | 1141 | 1322 | 1499 | 1841 |
| 1100                | 1048 | 1255 | 1454 | 1649 | 2025 |
| 1200                | 1144 | 1369 | 1586 | 1799 | 2209 |
| 1400                | 1334 | 1597 | 1851 | 2099 | 2577 |
| 1600                | 1525 | 1826 | 2115 | 2398 | 2946 |
| 1800                | 1715 | 2054 | 2380 | 2698 | 3314 |
| 2000                | 1906 | 2282 | 2644 | 2998 | 3682 |
| 2200                | 2097 | 2510 | 2908 |      |      |
| 2400                | 2287 | 2738 | 3173 |      |      |
| 2600                | 2478 | 2967 | 3437 |      |      |
| 2800                | 2668 | 3195 | 3702 |      |      |
| 3000                | 2859 | 3423 | 3966 |      |      |

**TYPE 21s** Watts 70/55/20 conform EN442-1: 2014: radiatoren en convectoren

| Hoogte (mm)           | 400  | 500  | 600  | 700  | 900  |
|-----------------------|------|------|------|------|------|
| W/m 70/55/20 (φ42,5K) | 770  | 921  | 1067 | 1210 | 1483 |
| n-exponent            | 1,31 | 1,32 | 1,32 | 1,32 | 1,33 |
| Lengte (mm)           | Watt | Watt | Watt | Watt | Watt |
| 400                   | 308  | 368  | 427  | 484  | 593  |
| 500                   | 385  | 460  | 533  | 605  | 742  |
| 600                   | 462  | 552  | 640  | 726  | 890  |
| 700                   | 539  | 644  | 747  | 847  | 1038 |
| 800                   | 616  | 737  | 853  | 968  | 1187 |
| 900                   | 693  | 829  | 960  | 1089 | 1335 |
| 1000                  | 770  | 921  | 1067 | 1210 | 1483 |
| 1100                  | 847  | 1013 | 1173 | 1331 | 1631 |
| 1200                  | 924  | 1105 | 1280 | 1451 | 1780 |
| 1400                  | 1078 | 1289 | 1493 | 1693 | 2076 |
| 1600                  | 1232 | 1473 | 1707 | 1935 | 2373 |
| 1800                  | 1386 | 1657 | 1920 | 2177 | 2670 |
| 2000                  | 1540 | 1841 | 2134 | 2419 | 2966 |
| 2200                  | 1695 | 2026 | 2347 |      |      |
| 2400                  | 1849 | 2210 | 2560 |      |      |
| 2600                  | 2003 | 2394 | 2774 |      |      |
| 2800                  | 2157 | 2578 | 2987 |      |      |
| 3000                  | 2311 | 2762 | 3200 |      |      |

TYPE 21s Watts 55/45/20 conform EN442-1: 2014: radiatoren en convectoren

**SUPER 6  
UNIVERSEEL**

| Hoogte (mm)         | 400  | 500  | 600  | 700  | 900  |
|---------------------|------|------|------|------|------|
| W/m 55/45/20 (φ30K) | 488  | 581  | 674  | 764  | 933  |
| n-exponent          | 1,31 | 1,32 | 1,32 | 1,32 | 1,33 |
| Lengte (mm)         | Watt | Watt | Watt | Watt | Watt |
| 400                 | 195  | 233  | 269  | 306  | 373  |
| 500                 | 244  | 291  | 337  | 382  | 467  |
| 600                 | 293  | 349  | 404  | 458  | 560  |
| 700                 | 342  | 407  | 472  | 535  | 653  |
| 800                 | 390  | 465  | 539  | 611  | 747  |
| 900                 | 439  | 523  | 606  | 687  | 840  |
| 1000                | 488  | 581  | 674  | 764  | 933  |
| 1100                | 537  | 639  | 741  | 840  | 1026 |
| 1200                | 586  | 698  | 808  | 917  | 1120 |
| 1400                | 683  | 814  | 943  | 1069 | 1307 |
| 1600                | 781  | 930  | 1078 | 1222 | 1493 |
| 1800                | 879  | 1046 | 1212 | 1375 | 1680 |
| 2000                | 976  | 1163 | 1347 | 1528 | 1866 |
| 2200                | 1074 | 1279 | 1482 |      |      |
| 2400                | 1171 | 1395 | 1617 |      |      |
| 2600                | 1269 | 1512 | 1751 |      |      |
| 2800                | 1367 | 1628 | 1886 |      |      |
| 3000                | 1464 | 1744 | 2021 |      |      |

**SUPER 6  
UNIVERSEEL**

**TYPE 22** Watts 75/65/20 conform EN442-1: 2014: radiatoren en convectoren

| Hoogte (mm)         | 300  | 400  | 500  | 600  | 700  | 900  |
|---------------------|------|------|------|------|------|------|
| W/m 75/65/20 (φ50K) | 942  | 1202 | 1449 | 1683 | 1907 | 2326 |
| n-exponent          | 1,31 | 1,32 | 1,32 | 1,33 | 1,33 | 1,34 |
| Lengte (mm)         | Watt | Watt | Watt | Watt | Watt | Watt |
| 400                 |      | 481  | 580  | 673  | 763  | 930  |
| 500                 | 471  | 601  | 725  | 842  | 954  | 1163 |
| 600                 | 566  | 721  | 869  | 1010 | 1144 | 1396 |
| 700                 | 659  | 841  | 1014 | 1178 | 1335 | 1628 |
| 800                 | 754  | 962  | 1159 | 1346 | 1526 | 1861 |
| 900                 | 848  | 1082 | 1304 | 1515 | 1716 | 2093 |
| 1000                | 942  | 1202 | 1449 | 1683 | 1907 | 2326 |
| 1100                | 1036 | 1322 | 1594 | 1851 | 2098 | 2559 |
| 1200                | 1130 | 1442 | 1739 | 2020 | 2288 | 2791 |
| 1400                | 1319 | 1683 | 2029 | 2356 | 2670 | 3256 |
| 1600                | 1507 | 1923 | 2318 | 2693 | 3051 | 3722 |
| 1800                | 1696 | 2164 | 2608 | 3029 | 3433 | 4187 |
| 2000                | 1884 | 2404 | 2898 | 3366 | 3814 | 4652 |
| 2200                | 2072 | 2644 | 3188 | 3703 |      |      |
| 2400                | 2261 | 2885 | 3478 | 4039 |      |      |
| 2600                | 2449 | 3125 | 3767 | 4376 |      |      |
| 2800                | 2638 | 3366 | 4057 | 4712 |      |      |
| 3000                | 2826 | 3606 | 4347 | 5049 |      |      |

**TYPE 22** Watts 70/55/20 conform EN442-1: 2014: radiatoren en convectoren

| Hoogte (mm)           | 300  | 400  | 500  | 600  | 700  | 900  |
|-----------------------|------|------|------|------|------|------|
| W/m 70/55/20 (φ42,5K) | 761  | 970  | 1169 | 1356 | 1536 | 1871 |
| n-exponent            | 1,31 | 1,32 | 1,32 | 1,33 | 1,33 | 1,34 |
| Lengte (mm)           | Watt | Watt | Watt | Watt | Watt | Watt |
| 400                   |      | 388  | 468  | 542  | 615  | 748  |
| 500                   | 381  | 485  | 585  | 678  | 768  | 935  |
| 600                   | 457  | 582  | 702  | 814  | 922  | 1122 |
| 700                   | 533  | 679  | 818  | 949  | 1075 | 1310 |
| 800                   | 609  | 776  | 935  | 1085 | 1229 | 1497 |
| 900                   | 685  | 873  | 1052 | 1220 | 1383 | 1684 |
| 1000                  | 761  | 970  | 1169 | 1356 | 1536 | 1871 |
| 1100                  | 837  | 1067 | 1286 | 1491 | 1690 | 2058 |
| 1200                  | 914  | 1164 | 1403 | 1627 | 1844 | 2245 |
| 1400                  | 1066 | 1358 | 1637 | 1898 | 2151 | 2619 |
| 1600                  | 1218 | 1552 | 1871 | 2169 | 2458 | 2993 |
| 1800                  | 1370 | 1746 | 2105 | 2441 | 2765 | 3367 |
| 2000                  | 1523 | 1940 | 2338 | 2712 | 3073 | 3742 |
| 2200                  | 1675 | 2134 | 2572 | 2983 |      |      |
| 2400                  | 1827 | 2328 | 2806 | 3254 |      |      |
| 2600                  | 1980 | 2522 | 3040 | 3525 |      |      |
| 2800                  | 2132 | 2716 | 3274 | 3796 |      |      |
| 3000                  | 2284 | 2910 | 3508 | 4068 |      |      |

## TYPE 22

Watts 55/45/20 conform EN442-1: 2014: radiatoren en convectoren

**SUPER 6  
UNIVERSEEL**

| Hoogte (mm)         | 300  | 400  | 500  | 600  | 700  | 900  |
|---------------------|------|------|------|------|------|------|
| W/m 55/45/20 (φ30K) | 482  | 612  | 738  | 853  | 967  | 1173 |
| n-exponent          | 1,31 | 1,32 | 1,32 | 1,33 | 1,33 | 1,34 |
| Lengte (mm)         | Watt | Watt | Watt | Watt | Watt | Watt |
| 400                 |      | 245  | 295  | 341  | 387  | 469  |
| 500                 | 241  | 306  | 369  | 427  | 483  | 587  |
| 600                 | 289  | 367  | 443  | 512  | 580  | 704  |
| 700                 | 337  | 429  | 517  | 597  | 677  | 821  |
| 800                 | 386  | 490  | 591  | 683  | 773  | 938  |
| 900                 | 434  | 551  | 664  | 768  | 870  | 1056 |
| 1000                | 482  | 612  | 738  | 853  | 967  | 1173 |
| 1100                | 531  | 674  | 812  | 938  | 1064 | 1290 |
| 1200                | 579  | 735  | 886  | 1024 | 1160 | 1408 |
| 1400                | 675  | 857  | 1034 | 1194 | 1353 | 1642 |
| 1600                | 772  | 980  | 1181 | 1365 | 1547 | 1877 |
| 1800                | 868  | 1102 | 1329 | 1536 | 1740 | 2112 |
| 2000                | 965  | 1225 | 1477 | 1706 | 1933 | 2346 |
| 2200                | 1061 | 1347 | 1624 | 1877 |      |      |
| 2400                | 1158 | 1470 | 1772 | 2048 |      |      |
| 2600                | 1254 | 1592 | 1920 | 2218 |      |      |
| 2800                | 1351 | 1715 | 2067 | 2389 |      |      |
| 3000                | 1447 | 1837 | 2215 | 2559 |      |      |

**SUPER 6  
UNIVERSEEL**

**TYPE 33** Watts 75/65/20 conform EN442-1: 2014: radiatoren en convectoren

| Hoogte (mm)         | 300  | 400  | 500  | 600  | 700  | 900  |
|---------------------|------|------|------|------|------|------|
| W/m 75/65/20 (φ50K) | 1334 | 1700 | 2048 | 2379 | 2696 | 3297 |
| n-exponent          | 1,29 | 1,30 | 1,31 | 1,32 | 1,33 | 1,34 |
| Lengte (mm)         | Watt | Watt | Watt | Watt | Watt | Watt |
| 400                 |      |      |      | 952  | 1078 | 1319 |
| 500                 |      |      | 1024 | 1190 | 1348 | 1649 |
| 600                 |      | 1020 | 1229 | 1427 | 1618 | 1978 |
| 700                 |      | 1190 | 1434 | 1665 | 1887 | 2308 |
| 800                 | 1067 | 1360 | 1638 | 1903 | 2157 | 2638 |
| 900                 | 1201 | 1530 | 1843 | 2141 | 2426 | 2967 |
| 1000                | 1334 | 1700 | 2048 | 2379 | 2696 | 3297 |
| 1100                | 1467 | 1870 | 2252 | 2617 | 2966 | 3627 |
| 1200                | 1601 | 2040 | 2458 | 2855 | 3235 | 3956 |
| 1300                | 1734 | 2210 | 2662 | 3093 | 3505 | 4286 |
| 1400                | 1868 | 2380 | 2867 | 3331 | 3774 | 4616 |
| 1600                | 2134 | 2720 | 3277 | 3806 | 4314 | 5275 |
| 1800                | 2401 | 3060 | 3686 | 4282 | 4853 | 5935 |
| 2000                | 2668 | 3400 | 4096 | 4758 | 5392 | 6594 |
| 2200                | 2935 | 3740 | 4506 | 5234 |      |      |
| 2400                | 3202 | 4080 | 4915 | 5710 |      |      |
| 2600                | 3468 | 4420 | 5325 | 6185 |      |      |
| 2800                | 3735 | 4760 | 5734 | 6661 |      |      |
| 3000                | 4002 | 5100 | 6144 | 7137 |      |      |

**TYPE 33** Watts 70/55/20 conform EN442-1: 2014: radiatoren en convectoren

| Hoogte (mm)           | 300  | 400  | 500  | 600  | 700  | 900  |
|-----------------------|------|------|------|------|------|------|
| W/m 70/55/20 (φ42,5K) | 1082 | 1376 | 1655 | 1920 | 2172 | 2652 |
| n-exponent            | 1,29 | 1,30 | 1,31 | 1,32 | 1,33 | 1,34 |
| Lengte (mm)           | Watt | Watt | Watt | Watt | Watt | Watt |
| 400                   |      |      |      | 768  | 869  | 1061 |
| 500                   |      |      | 828  | 960  | 1086 | 1326 |
| 600                   |      | 826  | 993  | 1152 | 1303 | 1591 |
| 700                   |      | 963  | 1159 | 1344 | 1520 | 1856 |
| 800                   | 865  | 1101 | 1324 | 1536 | 1738 | 2121 |
| 900                   | 974  | 1239 | 1490 | 1728 | 1955 | 2387 |
| 1000                  | 1082 | 1376 | 1655 | 1920 | 2172 | 2652 |
| 1100                  | 1190 | 1514 | 1821 | 2112 | 2389 | 2917 |
| 1200                  | 1298 | 1651 | 1986 | 2304 | 2606 | 3182 |
| 1300                  | 1406 | 1789 | 2152 | 2496 | 2824 | 3447 |
| 1400                  | 1514 | 1927 | 2317 | 2688 | 3041 | 3713 |
| 1600                  | 1731 | 2202 | 2648 | 3071 | 3475 | 4243 |
| 1800                  | 1947 | 2477 | 2979 | 3455 | 3909 | 4773 |
| 2000                  | 2163 | 2752 | 3311 | 3839 | 4344 | 5304 |
| 2200                  | 2380 | 3028 | 3642 | 4223 |      |      |
| 2400                  | 2596 | 3303 | 3973 | 4607 |      |      |
| 2600                  | 2812 | 3578 | 4304 | 4991 |      |      |
| 2800                  | 3029 | 3853 | 4635 | 5375 |      |      |
| 3000                  | 3245 | 4129 | 4966 | 5759 |      |      |

## TYPE 33

Watts 55/45/20 conform EN442-1: 2014: radiatoren en convectoren

## SUPER 6 UNIVERSEEL

| Hoogte (mm)         | 300  | 400  | 500  | 600  | 700  | 900  |
|---------------------|------|------|------|------|------|------|
| W/m 55/45/20 (φ30K) | 690  | 875  | 1049 | 1212 | 1367 | 1663 |
| n-exponent          | 1,29 | 1,30 | 1,31 | 1,32 | 1,33 | 1,34 |
| Lengte (mm)         | Watt | Watt | Watt | Watt | Watt | Watt |
| 400                 |      |      |      | 485  | 547  | 665  |
| 500                 |      |      | 524  | 606  | 683  | 831  |
| 600                 |      | 525  | 629  | 727  | 820  | 998  |
| 700                 |      | 613  | 734  | 849  | 957  | 1164 |
| 800                 | 552  | 700  | 839  | 970  | 1093 | 1330 |
| 900                 | 621  | 788  | 944  | 1091 | 1230 | 1497 |
| 1000                | 690  | 875  | 1049 | 1212 | 1367 | 1663 |
| 1100                | 759  | 963  | 1154 | 1333 | 1504 | 1829 |
| 1200                | 828  | 1050 | 1259 | 1455 | 1640 | 1995 |
| 1300                | 897  | 1138 | 1363 | 1576 | 1777 | 2162 |
| 1400                | 966  | 1225 | 1468 | 1697 | 1913 | 2328 |
| 1600                | 1104 | 1400 | 1678 | 1939 | 2187 | 2660 |
| 1800                | 1242 | 1575 | 1888 | 2182 | 2460 | 2993 |
| 2000                | 1380 | 1750 | 2098 | 2424 | 2733 | 3326 |
| 2200                | 1518 | 1925 | 2307 | 2667 |      |      |
| 2400                | 1656 | 2100 | 2517 | 2909 |      |      |
| 2600                | 1795 | 2275 | 2727 | 3152 |      |      |
| 2800                | 1933 | 2450 | 2937 | 3394 |      |      |
| 3000                | 2071 | 2625 | 3147 | 3636 |      |      |

Super 6 Design

TYPE 21s Watts 75/65/20 conform EN442-1: 2014: radiatoren en convectoren

| Hoogte (mm)         | 400  | 500  | 600  | 700  | 900  |
|---------------------|------|------|------|------|------|
| W/m 75/65/20 (φ50K) | 868  | 1034 | 1192 | 1342 | 1623 |
| n-exponent          | 1,29 | 1,29 | 1,30 | 1,30 | 1,29 |
| Lengte (mm)         | Watt | Watt | Watt | Watt | Watt |
| 400                 | 347  | 414  | 477  | 537  |      |
| 500                 |      |      |      | 671  | 812  |
| 600                 | 521  | 620  | 715  | 805  | 974  |
| 700                 |      |      |      | 939  | 1136 |
| 800                 | 694  | 827  | 954  | 1074 | 1298 |
| 900                 |      |      |      | 1208 | 1461 |
| 1000                | 868  | 1034 | 1192 | 1342 |      |
| 1200                | 1042 | 1241 | 1430 | 1610 |      |
| 1400                | 1215 | 1448 | 1669 |      |      |
| 1600                | 1389 | 1654 | 1907 |      |      |
| 1800                | 1562 | 1861 | 2146 |      |      |
| 2000                | 1736 | 2068 | 2384 |      |      |
| 2400                |      | 2482 | 2861 |      |      |
| 3000                |      | 3102 |      |      |      |

TYPE 21s Watts 70/55/20 conform EN442-1: 2014: radiatoren en convectoren

| Hoogte (mm)           | 400  | 500  | 600  | 700  | 900  |
|-----------------------|------|------|------|------|------|
| W/m 70/55/20 (φ42,5K) | 704  | 838  | 965  | 1086 | 1316 |
| n-exponent            | 1,29 | 1,29 | 1,30 | 1,30 | 1,29 |
| Lengte (mm)           | Watt | Watt | Watt | Watt | Watt |
| 400                   | 282  | 335  | 386  | 435  |      |
| 500                   |      |      |      | 543  | 658  |
| 600                   | 422  | 503  | 579  | 652  | 790  |
| 700                   |      |      |      | 760  | 921  |
| 800                   | 563  | 671  | 772  | 869  | 1053 |
| 900                   |      |      |      | 978  | 1184 |
| 1000                  | 704  | 838  | 965  | 1086 |      |
| 1200                  | 845  | 1006 | 1158 | 1304 |      |
| 1400                  | 985  | 1174 | 1351 |      |      |
| 1600                  | 1126 | 1342 | 1544 |      |      |
| 1800                  | 1267 | 1509 | 1737 |      |      |
| 2000                  | 1408 | 1677 | 1930 |      |      |
| 2400                  |      | 2012 | 2316 |      |      |
| 3000                  |      | 2515 |      |      |      |

TYPE 21s Watts 55/45/20 conform EN442-1: 2014: radiatoren en convectoren

| Hoogte (mm)         | 400  | 500  | 600  | 700  | 900  |
|---------------------|------|------|------|------|------|
| W/m 55/45/20 (φ30K) | 449  | 535  | 614  | 691  | 840  |
| n-exponent          | 1,29 | 1,29 | 1,30 | 1,30 | 1,29 |
| Lengte (mm)         | Watt | Watt | Watt | Watt | Watt |
| 400                 | 180  | 214  | 245  | 276  |      |
| 500                 |      |      |      | 345  | 420  |
| 600                 | 269  | 321  | 368  | 414  | 504  |
| 700                 |      |      |      | 484  | 588  |
| 800                 | 359  | 428  | 491  | 553  | 672  |
| 900                 |      |      |      | 622  | 756  |
| 1000                | 449  | 535  | 614  | 691  |      |
| 1200                | 539  | 642  | 736  | 829  |      |
| 1400                | 629  | 749  | 859  |      |      |
| 1600                | 719  | 856  | 982  |      |      |
| 1800                | 808  | 963  | 1104 |      |      |
| 2000                | 898  | 1070 | 1227 |      |      |
| 2400                |      | 1284 | 1473 |      |      |
| 3000                |      | 1605 |      |      |      |



## SUPER 6 DESIGN

**TYPE 22** Watts 75/65/20 conform EN442-1: 2014: radiatoren en convectoren

| Hoogte (mm)         | 300  | 400  | 500  | 600  | 700  | 900  |
|---------------------|------|------|------|------|------|------|
| W/m 75/65/20 (φ50K) | 878  | 1104 | 1317 | 1521 | 1717 | 2089 |
| n-exponent          | 1,30 | 1,30 | 1,31 | 1,31 | 1,30 | 1,28 |
| Lengte (mm)         | Watt | Watt | Watt | Watt | Watt | Watt |
| 400                 |      | 442  |      | 608  | 687  | 836  |
| 500                 |      |      |      | 761  | 859  | 1045 |
| 600                 | 527  | 662  | 790  | 913  | 1030 | 1253 |
| 700                 |      |      |      | 1065 | 1202 | 1462 |
| 800                 | 702  | 883  | 1054 | 1217 | 1374 | 1671 |
| 900                 |      |      |      | 1369 |      | 1880 |
| 1000                | 878  | 1104 | 1317 | 1521 | 1717 | 2089 |
| 1200                | 1054 | 1325 | 1580 | 1825 | 2060 | 2507 |
| 1400                | 1229 | 1546 | 1844 | 2129 |      |      |
| 1600                | 1405 | 1766 | 2107 | 2434 |      |      |
| 1800                | 1580 | 1987 | 2371 | 2738 |      |      |
| 2000                | 1756 | 2208 | 2634 | 3042 |      |      |
| 2400                | 2107 | 2650 | 3161 | 3650 |      |      |
| 3000                | 2634 | 3312 | 3951 | 4563 |      |      |

**TYPE 22** Watts 70/55/20 conform EN442-1: 2014: radiatoren en convectoren

| Hoogte (mm)           | 300  | 400  | 500  | 600  | 700  | 900  |
|-----------------------|------|------|------|------|------|------|
| W/m 70/55/20 (φ42,5K) | 711  | 894  | 1064 | 1229 | 1390 | 1697 |
| n-exponent            | 1,30 | 1,30 | 1,31 | 1,31 | 1,30 | 1,28 |
| Lengte (mm)           | Watt | Watt | Watt | Watt | Watt | Watt |
| 400                   |      | 357  |      | 492  | 556  | 679  |
| 500                   |      |      |      | 615  | 695  | 848  |
| 600                   | 426  | 536  | 639  | 738  | 834  | 1018 |
| 700                   |      |      |      | 861  | 973  | 1188 |
| 800                   | 569  | 715  | 852  | 983  | 1112 | 1357 |
| 900                   |      |      |      | 1106 |      | 1527 |
| 1000                  | 711  | 894  | 1064 | 1229 | 1390 | 1697 |
| 1200                  | 853  | 1072 | 1277 | 1475 | 1668 | 2036 |
| 1400                  | 995  | 1251 | 1490 | 1721 |      |      |
| 1600                  | 1137 | 1430 | 1703 | 1967 |      |      |
| 1800                  | 1279 | 1609 | 1916 | 2213 |      |      |
| 2000                  | 1422 | 1787 | 2129 | 2459 |      |      |
| 2400                  | 1706 | 2145 | 2555 | 2950 |      |      |
| 3000                  | 2132 | 2681 | 3193 | 3688 |      |      |

**TYPE 22** Watts 55/45/20 conform EN442-1: 2014: radiatoren en convectoren

| Hoogte (mm)         | 300  | 400  | 500  | 600  | 700  | 900  |
|---------------------|------|------|------|------|------|------|
| W/m 55/45/20 (φ30K) | 452  | 568  | 674  | 779  | 884  | 1086 |
| n-exponent          | 1,30 | 1,30 | 1,31 | 1,31 | 1,30 | 1,28 |
| Lengte (mm)         | Watt | Watt | Watt | Watt | Watt | Watt |
| 400                 |      | 227  |      | 312  | 354  | 435  |
| 500                 |      |      |      | 389  | 442  | 543  |
| 600                 | 271  | 341  | 405  | 467  | 530  | 652  |
| 700                 |      |      |      | 545  | 619  | 760  |
| 800                 | 362  | 455  | 540  | 623  | 707  | 869  |
| 900                 |      |      |      | 701  |      | 978  |
| 1000                | 452  | 568  | 674  | 779  | 884  | 1086 |
| 1200                | 542  | 682  | 809  | 935  | 1061 | 1304 |
| 1400                | 633  | 796  | 944  | 1091 |      |      |
| 1600                | 723  | 909  | 1079 | 1246 |      |      |
| 1800                | 814  | 1023 | 1214 | 1402 |      |      |
| 2000                | 904  | 1137 | 1349 | 1558 |      |      |
| 2400                | 1085 | 1364 | 1619 | 1869 |      |      |
| 3000                | 1356 | 1705 | 2023 | 2337 |      |      |

Super 6 Design

TYPE 33 Watts 75/65/20 conform EN442-1: 2014: radiatoren en convectoren

| Hoogte (mm)         | 300  | 400  | 500  | 600  | 700  | 900  |
|---------------------|------|------|------|------|------|------|
| W/m 75/65/20 (φ50K) | 1236 | 1532 | 1822 | 2110 | 2399 | 2991 |
| n-exponent          | 1,32 | 1,32 | 1,32 | 1,32 | 1,32 | 1,32 |
| Lengte (mm)         | Watt | Watt | Watt | Watt | Watt | Watt |
| 400                 |      |      |      | 844  | 960  | 1196 |
| 500                 |      |      |      |      | 1200 | 1496 |
| 600                 |      |      |      | 1266 | 1439 | 1795 |
| 700                 |      |      |      | 1477 | 1679 | 2094 |
| 800                 | 989  |      | 1458 | 1688 | 1919 | 2393 |
| 900                 |      |      |      | 1899 | 2159 | 2692 |
| 1000                | 1236 | 1532 | 1822 | 2110 | 2399 | 2991 |
| 1200                | 1483 | 1838 | 2186 | 2532 | 2879 | 3589 |
| 1400                | 1730 | 2145 | 2551 | 2954 |      | 4187 |
| 1600                | 1978 | 2451 | 2915 | 3376 |      |      |
| 1800                | 2225 | 2758 |      | 3798 |      |      |
| 2000                | 2472 | 3064 | 3644 | 4220 |      |      |
| 2400                |      |      | 4373 |      |      |      |

TYPE 33 Watts 70/55/20 conform EN442-1: 2014: radiatoren en convectoren

| Hoogte (mm)           | 300  | 400  | 500  | 600  | 700  | 900  |
|-----------------------|------|------|------|------|------|------|
| W/m 70/55/20 (φ42,5K) | 997  | 1236 | 1470 | 1703 | 1936 | 2414 |
| n-exponent            | 1,32 | 1,32 | 1,32 | 1,32 | 1,32 | 1,32 |
| Lengte (mm)           | Watt | Watt | Watt | Watt | Watt | Watt |
| 400                   |      |      |      | 681  | 774  | 965  |
| 500                   |      |      |      |      | 968  | 1207 |
| 600                   |      |      |      | 1022 | 1161 | 1448 |
| 700                   |      |      |      | 1192 | 1355 | 1689 |
| 800                   | 798  |      | 1176 | 1362 | 1549 | 1931 |
| 900                   |      |      |      | 1532 | 1742 | 2172 |
| 1000                  | 997  | 1236 | 1470 | 1703 | 1936 | 2414 |
| 1200                  | 1197 | 1483 | 1764 | 2043 | 2323 | 2896 |
| 1400                  | 1396 | 1731 | 2058 | 2384 |      | 3379 |
| 1600                  | 1596 | 1978 | 2352 | 2724 |      |      |
| 1800                  | 1795 | 2225 |      | 3065 |      |      |
| 2000                  | 1995 | 2472 | 2940 | 3405 |      |      |
| 2400                  |      |      | 3529 |      |      |      |

TYPE 33 Watts 55/45/20 conform EN442-1: 2014: radiatoren en convectoren

| Hoogte (mm)         | 300  | 400  | 500  | 600  | 700  | 900  |
|---------------------|------|------|------|------|------|------|
| W/m 55/45/20 (φ30K) | 630  | 781  | 928  | 1075 | 1222 | 1524 |
| n-exponent          | 1,32 | 1,32 | 1,32 | 1,32 | 1,32 | 1,32 |
| Lengte (mm)         | Watt | Watt | Watt | Watt | Watt | Watt |
| 400                 |      |      |      | 430  | 489  | 610  |
| 500                 |      |      |      |      | 611  | 762  |
| 600                 |      |      |      | 645  | 733  | 914  |
| 700                 |      |      |      | 753  | 856  | 1067 |
| 800                 | 504  |      | 743  | 860  | 978  | 1219 |
| 900                 |      |      |      | 968  | 1100 | 1372 |
| 1000                | 630  | 781  | 928  | 1075 | 1222 | 1524 |
| 1200                | 756  | 937  | 1114 | 1290 | 1467 | 1829 |
| 1400                | 882  | 1093 | 1300 | 1505 |      | 2134 |
| 1600                | 1008 | 1249 | 1485 | 1720 |      |      |
| 1800                | 1134 | 1405 |      | 1935 |      |      |
| 2000                | 1260 | 1561 | 1857 | 2150 |      |      |
| 2400                |      |      | 2228 |      |      |      |

# Casual

SUPER 6 DESIGN

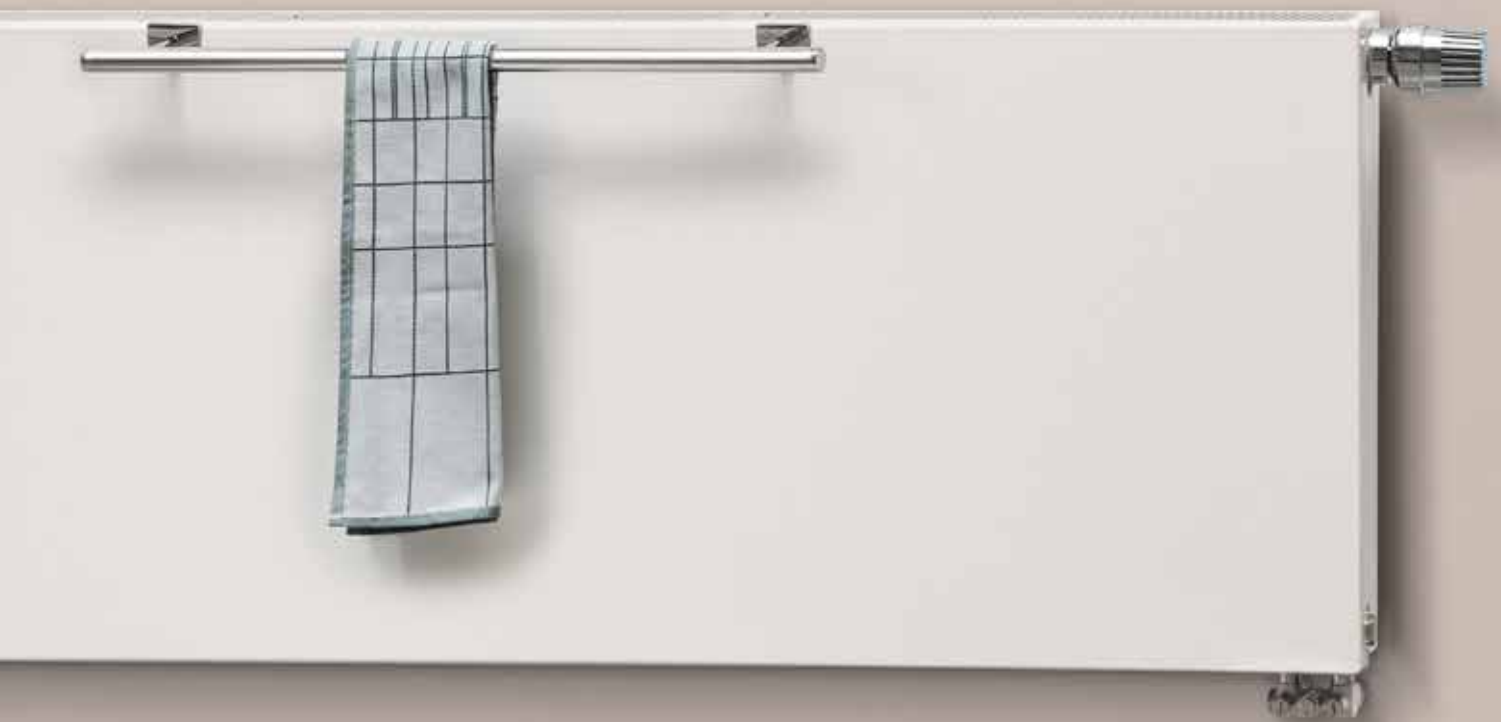

CENTRAL (GALVA)



TYPE 11 Watts 75/65/20 conform EN442-1: 2014: radiatoren en convectoren

| Hoogte (mm)         | 400  | 500  | 600  | 700  | 900  |
|---------------------|------|------|------|------|------|
| W/m 75/65/20 (φ50K) | 697  | 840  | 979  | 1117 | 1390 |
| n-exponent          | 1,24 | 1,25 | 1,27 | 1,28 | 1,30 |
| Lengte (mm)         | Watt | Watt | Watt | Watt | Watt |
| 400                 | 279  | 336  | 392  | 447  | 556  |
| 600                 |      | 504  | 587  | 670  | 834  |
| 700                 |      |      | 685  |      | 973  |
| 800                 | 558  | 672  | 783  | 894  | 1112 |
| 900                 |      |      | 881  |      | 1251 |
| 1000                |      | 840  | 979  | 1117 |      |
| 1200                | 836  | 1008 | 1175 | 1340 | 1668 |
| 1400                |      | 1176 | 1371 | 1564 | 1946 |
| 1600                |      | 1344 | 1567 |      | 2224 |
| 1800                |      | 1512 | 1762 | 2011 | 2502 |
| 2000                | 1394 |      | 1958 |      |      |

TYPE 11 Watts 70/55/20 conform EN442-1: 2014: radiatoren en convectoren

| Hoogte (mm)           | 400  | 500  | 600  | 700  | 900  |
|-----------------------|------|------|------|------|------|
| W/m 70/55/20 (φ42,5K) | 565  | 679  | 789  | 899  | 1114 |
| n-exponent            | 1,24 | 1,25 | 1,27 | 1,28 | 1,30 |
| Lengte (mm)           | Watt | Watt | Watt | Watt | Watt |
| 400                   | 226  | 272  | 316  | 359  | 446  |
| 600                   |      | 407  | 473  | 539  | 668  |
| 700                   |      |      | 552  |      | 780  |
| 800                   | 452  | 543  | 631  | 719  | 891  |
| 900                   |      |      | 710  |      | 1003 |
| 1000                  |      | 679  | 789  | 899  |      |
| 1200                  | 678  | 815  | 947  | 1078 | 1337 |
| 1400                  |      | 951  | 1105 | 1258 | 1560 |
| 1600                  |      | 1086 | 1262 |      | 1783 |
| 1800                  |      | 1222 | 1420 | 1617 | 2005 |
| 2000                  | 1130 |      | 1578 |      |      |

TYPE 11 Watts 55/45/20 conform EN442-1: 2014: radiatoren en convectoren

| Hoogte (mm)         | 400  | 500  | 600  | 700  | 900  |
|---------------------|------|------|------|------|------|
| W/m 55/45/20 (φ30K) | 368  | 439  | 507  | 576  | 708  |
| n-exponent          | 1,24 | 1,25 | 1,27 | 1,28 | 1,30 |
| Lengte (mm)         | Watt | Watt | Watt | Watt | Watt |
| 400                 | 147  | 176  | 203  | 230  | 283  |
| 600                 |      | 264  | 304  | 345  | 425  |
| 700                 |      |      | 355  |      | 496  |
| 800                 | 294  | 351  | 406  | 460  | 567  |
| 900                 |      |      | 457  |      | 638  |
| 1000                |      | 439  | 507  | 576  |      |
| 1200                | 441  | 527  | 609  | 691  | 850  |
| 1400                |      | 615  | 710  | 806  | 992  |
| 1600                |      | 703  | 812  |      | 1133 |
| 1800                |      | 791  | 913  | 1036 | 1275 |
| 2000                | 736  |      | 1015 |      |      |

## CENTRAL (GALVA)

TYPE 21s Watts 75/65/20 conform EN442-1: 2014: radiatoren en convectoren

| Hoogte (mm)         | 300  | 400  | 500  | 600  | 700  | 900  |
|---------------------|------|------|------|------|------|------|
| W/m 75/65/20 (φ50K) | 755  | 953  | 1141 | 1322 | 1499 | 1841 |
| n-exponent          | 1,31 | 1,31 | 1,32 | 1,32 | 1,32 | 1,33 |
| Lengte (mm)         | Watt | Watt | Watt | Watt | Watt | Watt |
| 400                 |      | 381  | 456  | 529  | 600  | 736  |
| 500                 |      | 477  | 571  | 661  | 750  | 921  |
| 600                 |      | 572  | 685  | 793  | 899  | 1105 |
| 700                 |      | 667  | 799  | 925  | 1049 | 1289 |
| 800                 |      | 762  | 913  | 1058 | 1199 | 1473 |
| 900                 | 680  | 858  | 1027 | 1190 | 1349 | 1657 |
| 1000                | 755  | 953  | 1141 | 1322 | 1499 | 1841 |
| 1100                | 831  | 1048 | 1255 | 1454 |      |      |
| 1200                | 906  | 1144 | 1369 | 1586 | 1799 | 2209 |
| 1400                | 1057 | 1334 | 1597 | 1851 | 2099 | 2577 |
| 1600                | 1208 | 1525 | 1826 | 2115 | 2398 | 2946 |
| 1800                | 1359 | 1715 | 2054 | 2380 | 2698 | 3314 |
| 2000                | 1510 | 1906 | 2282 | 2644 | 2998 |      |
| 2200                | 1661 | 2097 | 2510 | 2908 |      |      |
| 2400                | 1812 | 2287 | 2738 | 3173 |      |      |
| 2600                | 1963 | 2478 | 2967 | 3437 |      |      |
| 2800                |      | 2668 |      | 3702 |      |      |
| 3000                |      | 2859 | 3423 |      |      |      |

TYPE 21s Watts 70/55/20 conform EN442-1: 2014: radiatoren en convectoren

| Hoogte (mm)           | 300  | 400  | 500  | 600  | 700  | 900  |
|-----------------------|------|------|------|------|------|------|
| W/m 70/55/20 (φ42,5K) | 610  | 770  | 921  | 1067 | 1210 | 1483 |
| n-exponent            | 1,31 | 1,31 | 1,32 | 1,32 | 1,32 | 1,33 |
| Lengte (mm)           | Watt | Watt | Watt | Watt | Watt | Watt |
| 400                   |      | 308  | 368  | 427  | 484  | 593  |
| 500                   |      | 385  | 460  | 533  | 605  | 742  |
| 600                   |      | 462  | 552  | 640  | 726  | 890  |
| 700                   |      | 539  | 644  | 747  | 847  | 1038 |
| 800                   |      | 616  | 737  | 853  | 968  | 1187 |
| 900                   | 549  | 693  | 829  | 960  | 1089 | 1335 |
| 1000                  | 610  | 770  | 921  | 1067 | 1210 | 1483 |
| 1100                  | 671  | 847  | 1013 | 1173 |      |      |
| 1200                  | 732  | 924  | 1105 | 1280 | 1451 | 1780 |
| 1400                  | 854  | 1078 | 1289 | 1493 | 1693 | 2076 |
| 1600                  | 915  | 1155 | 1381 | 1600 | 1814 | 2225 |
| 1800                  | 976  | 1232 | 1473 | 1707 | 1935 | 2373 |
| 2000                  | 1098 | 1386 | 1657 | 1920 | 2177 |      |
| 2200                  | 1220 | 1540 | 1841 | 2134 |      |      |
| 2400                  | 1342 | 1695 | 2026 | 2347 |      |      |
| 2600                  | 1465 | 1849 | 2210 | 2560 |      |      |
| 2800                  |      | 2157 |      | 2987 |      |      |
| 3000                  |      | 2311 | 2762 |      |      |      |

TYPE 21s Watts 55/45/20 conform EN442-1: 2014: radiatoren en convectoren

| Hoogte (mm)         | 300  | 400  | 500  | 600  | 700  | 900  |
|---------------------|------|------|------|------|------|------|
| W/m 55/45/20 (φ30K) | 387  | 488  | 581  | 674  | 764  | 933  |
| n-exponent          | 1,31 | 1,31 | 1,32 | 1,32 | 1,32 | 1,33 |
| Lengte (mm)         | Watt | Watt | Watt | Watt | Watt | Watt |
| 400                 |      | 195  | 233  | 269  | 306  | 373  |
| 500                 |      | 244  | 291  | 337  | 382  | 467  |
| 600                 |      | 293  | 349  | 404  | 458  | 560  |
| 700                 |      | 342  | 407  | 472  | 535  | 653  |
| 800                 |      | 390  | 465  | 539  | 611  | 747  |
| 900                 | 348  | 439  | 523  | 606  | 687  | 840  |
| 1000                | 387  | 488  | 581  | 674  | 764  | 933  |
| 1100                | 425  | 537  | 639  | 741  |      |      |
| 1200                | 464  | 586  | 698  | 808  | 917  | 1120 |
| 1400                | 541  | 683  | 814  | 943  | 1069 | 1307 |
| 1600                | 619  | 781  | 930  | 1078 | 1222 | 1493 |
| 1800                | 696  | 879  | 1046 | 1212 | 1375 | 1680 |
| 2000                | 773  | 976  | 1163 | 1347 | 1528 |      |
| 2200                | 851  | 1074 | 1279 | 1482 |      |      |
| 2400                | 928  | 1171 | 1395 | 1617 |      |      |
| 2600                | 1005 | 1269 | 1512 | 1751 |      |      |
| 2800                |      | 1367 |      | 1886 |      |      |
| 3000                |      | 1464 | 1744 |      |      |      |

CENTRAL (GALVA)

TYPE 22 Watts 75/65/20 conform EN442-1: 2014: radiatoren en convectoren

| Hoogte (mm)         | 300  | 400  | 500  | 600  | 700  | 900  |
|---------------------|------|------|------|------|------|------|
| W/m 75/65/20 (φ50K) | 942  | 1202 | 1449 | 1683 | 1907 | 2326 |
| n-exponent          | 1,31 | 1,32 | 1,32 | 1,33 | 1,33 | 1,34 |
| Lengte (mm)         | Watt | Watt | Watt | Watt | Watt | Watt |
| 400                 |      | 481  | 580  | 673  | 763  | 930  |
| 500                 |      | 601  | 725  | 842  | 954  | 1163 |
| 600                 | 565  | 721  | 869  | 1010 | 1144 | 1396 |
| 700                 |      | 841  | 1014 | 1178 | 1335 | 1628 |
| 800                 | 754  | 962  | 1159 | 1346 | 1526 | 1861 |
| 900                 | 848  | 1082 | 1304 | 1515 | 1716 | 2093 |
| 1000                | 942  | 1202 | 1449 | 1683 | 1907 | 2326 |
| 1100                | 1036 | 1322 | 1594 | 1851 |      | 2559 |
| 1200                | 1130 | 1442 | 1739 | 2020 | 2288 | 2791 |
| 1400                | 1319 | 1683 | 2029 | 2356 | 2670 | 3256 |
| 1600                | 1507 | 1923 | 2318 | 2693 | 3051 | 3722 |
| 1800                | 1696 | 2164 | 2608 | 3029 | 3433 | 4187 |
| 2000                | 1884 | 2404 | 2898 | 3366 | 3814 | 4652 |
| 2200                | 2072 | 2644 | 3188 | 3703 |      |      |
| 2400                | 2261 | 2885 | 3478 | 4039 |      |      |
| 2600                | 2449 | 3125 | 3767 | 4376 |      |      |
| 2800                | 2638 | 3366 | 4057 | 4712 |      |      |
| 3000                | 2826 | 3606 | 4347 | 5049 |      |      |

TYPE 22 Watts 70/55/20 conform EN442-1: 2014: radiatoren en convectoren

| Hoogte (mm)           | 300  | 400  | 500  | 600  | 700  | 900  |
|-----------------------|------|------|------|------|------|------|
| W/m 70/55/20 (φ42,5K) | 761  | 970  | 1169 | 1356 | 1536 | 1871 |
| n-exponent            | 1,31 | 1,32 | 1,32 | 1,33 | 1,33 | 1,34 |
| Lengte (mm)           | Watt | Watt | Watt | Watt | Watt | Watt |
| 400                   |      | 388  | 468  | 542  | 615  | 748  |
| 500                   |      | 485  | 585  | 678  | 768  | 935  |
| 600                   | 457  | 582  | 702  | 814  | 922  | 1122 |
| 700                   |      | 679  | 818  | 949  | 1075 | 1310 |
| 800                   | 609  | 776  | 935  | 1085 | 1229 | 1497 |
| 900                   | 685  | 873  | 1052 | 1220 | 1383 | 1684 |
| 1000                  | 761  | 970  | 1169 | 1356 | 1536 | 1871 |
| 1100                  | 837  | 1067 | 1286 | 1491 |      | 2058 |
| 1200                  | 914  | 1164 | 1403 | 1627 | 1844 | 2245 |
| 1400                  | 1066 | 1358 | 1637 | 1898 | 2151 | 2619 |
| 1600                  | 1218 | 1552 | 1871 | 2169 | 2458 | 2993 |
| 1800                  | 1370 | 1746 | 2105 | 2441 | 2765 | 3367 |
| 2000                  | 1523 | 1940 | 2338 | 2712 | 3073 | 3742 |
| 2200                  | 1675 | 2134 | 2572 | 2983 |      |      |
| 2400                  | 1827 | 2328 | 2806 | 3254 |      |      |
| 2600                  | 1980 | 2522 | 3040 | 3525 |      |      |
| 2800                  | 2132 | 2716 | 3274 | 3796 |      |      |
| 3000                  | 2284 | 2910 | 3508 | 4068 |      |      |

TYPE 22 Watts 55/45/20 conform EN442-1: 2014: radiatoren en convectoren

| Hoogte (mm)         | 300  | 400  | 500  | 600  | 700  | 900  |
|---------------------|------|------|------|------|------|------|
| W/m 55/45/20 (φ30K) | 482  | 612  | 738  | 853  | 967  | 1173 |
| n-exponent          | 1,31 | 1,32 | 1,32 | 1,33 | 1,33 | 1,34 |
| Lengte (mm)         | Watt | Watt | Watt | Watt | Watt | Watt |
| 400                 |      | 245  | 295  | 341  | 387  | 469  |
| 500                 |      | 306  | 369  | 427  | 483  | 587  |
| 600                 | 289  | 367  | 443  | 512  | 580  | 704  |
| 700                 |      | 429  | 517  | 597  | 677  | 821  |
| 800                 | 386  | 490  | 591  | 683  | 773  | 938  |
| 900                 | 434  | 551  | 664  | 768  | 870  | 1056 |
| 1000                | 482  | 612  | 738  | 853  | 967  | 1173 |
| 1100                | 531  | 674  | 812  | 938  |      | 1290 |
| 1200                | 579  | 735  | 886  | 1024 | 1160 | 1408 |
| 1400                | 675  | 857  | 1034 | 1194 | 1353 | 1642 |
| 1600                | 772  | 980  | 1181 | 1365 | 1547 | 1877 |
| 1800                | 868  | 1102 | 1329 | 1536 | 1740 | 2112 |
| 2000                | 965  | 1225 | 1477 | 1706 | 1933 | 2346 |
| 2200                | 1061 | 1347 | 1624 | 1877 |      |      |
| 2400                | 1158 | 1470 | 1772 | 2048 |      |      |
| 2600                | 1254 | 1592 | 1920 | 2218 |      |      |
| 2800                | 1351 | 1715 | 2067 | 2389 |      |      |
| 3000                | 1447 | 1837 | 2215 | 2559 |      |      |

## CENTRAL (GALVA)

**TYPE 33** Watts 75/65/20 conform EN442-1: 2014: radiatoren en convectoren

| Hoogte (mm)         | 300  | 400  | 500  | 600  | 700  | 900  |
|---------------------|------|------|------|------|------|------|
| W/m 75/65/20 (φ50K) | 1334 | 1700 | 2048 | 2379 | 2696 | 3297 |
| n-exponent          | 1,29 | 1,30 | 1,31 | 1,32 | 1,33 | 1,34 |
| Lengte (mm)         | Watt | Watt | Watt | Watt | Watt | Watt |
| 400                 |      |      |      | 952  | 1078 | 1319 |
| 500                 |      |      | 1024 | 1190 | 1348 | 1649 |
| 600                 |      | 1020 | 1229 | 1427 | 1618 | 1978 |
| 700                 |      |      | 1434 | 1665 | 1887 | 2308 |
| 800                 | 1067 | 1360 | 1638 | 1903 | 2157 | 2638 |
| 900                 | 1201 | 1530 | 1843 | 2141 | 2426 | 2967 |
| 1000                | 1334 | 1700 | 2048 | 2379 | 2696 | 3297 |
| 1100                |      |      |      |      |      | 3627 |
| 1200                | 1601 | 2040 | 2458 | 2855 | 3235 | 3956 |
| 1400                | 1868 | 2380 | 2867 | 3331 | 3774 | 4616 |
| 1600                | 2134 | 2720 | 3277 | 3806 | 4314 | 5275 |
| 1800                | 2401 | 3060 | 3686 | 4282 | 4853 | 5935 |
| 2000                | 2668 | 3400 | 4096 | 4758 | 5392 | 6594 |
| 2200                | 2935 | 3740 | 4506 | 5234 |      |      |
| 2400                | 3202 | 4080 | 4915 | 5710 |      |      |
| 2600                | 3468 | 4420 | 5325 | 6185 |      |      |
| 2800                | 3735 | 4760 | 5734 |      |      |      |
| 3000                | 4002 | 5100 | 6144 |      |      |      |

**TYPE 33** Watts 70/55/20 conform EN442-1: 2014: radiatoren en convectoren

| Hoogte (mm)           | 300  | 400  | 500  | 600  | 700  | 900  |
|-----------------------|------|------|------|------|------|------|
| W/m 70/55/20 (φ42,5K) | 1082 | 1376 | 1655 | 1920 | 2172 | 2652 |
| n-exponent            | 1,29 | 1,30 | 1,31 | 1,32 | 1,33 | 1,34 |
| Lengte (mm)           | Watt | Watt | Watt | Watt | Watt | Watt |
| 400                   |      |      |      | 768  | 869  | 1061 |
| 500                   |      |      | 828  | 960  | 1086 | 1326 |
| 600                   |      | 826  | 993  | 1152 | 1303 | 1591 |
| 700                   |      |      | 1159 | 1344 | 1520 | 1856 |
| 800                   | 865  | 1101 | 1324 | 1536 | 1738 | 2121 |
| 900                   | 974  | 1239 | 1490 | 1728 | 1955 | 2387 |
| 1000                  | 1082 | 1376 | 1655 | 1920 | 2172 | 2652 |
| 1100                  |      |      |      |      |      | 2917 |
| 1200                  | 1298 | 1651 | 1986 | 2304 | 2606 | 3182 |
| 1400                  | 1514 | 1927 | 2317 | 2688 | 3041 | 3713 |
| 1600                  | 1731 | 2202 | 2648 | 3071 | 3475 | 4243 |
| 1800                  | 1947 | 2477 | 2979 | 3455 | 3909 | 4773 |
| 2000                  | 2163 | 2752 | 3311 | 3839 | 4344 | 5304 |
| 2200                  | 2380 | 3028 | 3642 | 4223 |      |      |
| 2400                  | 2596 | 3303 | 3973 | 4607 |      |      |
| 2600                  | 2812 | 3578 | 4304 | 4991 |      |      |
| 2800                  | 3029 | 3853 | 4635 |      |      |      |
| 3000                  | 3245 | 4129 | 4966 |      |      |      |

**TYPE 33** Watts 55/45/20 conform EN442-1: 2014: radiatoren en convectoren

| Hoogte (mm)         | 300  | 400  | 500  | 600  | 700  | 900  |
|---------------------|------|------|------|------|------|------|
| W/m 55/45/20 (φ30K) | 690  | 875  | 1049 | 1212 | 1367 | 1663 |
| n-exponent          | 1,29 | 1,30 | 1,31 | 1,32 | 1,33 | 1,34 |
| Lengte (mm)         | Watt | Watt | Watt | Watt | Watt | Watt |
| 400                 |      |      |      | 485  | 547  | 665  |
| 500                 |      |      | 524  | 606  | 683  | 831  |
| 600                 |      | 525  | 629  | 727  | 820  | 998  |
| 700                 |      |      | 734  | 849  | 957  | 1164 |
| 800                 | 552  | 700  | 839  | 970  | 1093 | 1330 |
| 900                 | 621  | 788  | 944  | 1091 | 1230 | 1497 |
| 1000                | 690  | 875  | 1049 | 1212 | 1367 | 1663 |
| 1100                |      |      |      |      |      | 1829 |
| 1200                | 828  | 1050 | 1259 | 1455 | 1640 | 1995 |
| 1400                | 966  | 1225 | 1468 | 1697 | 1913 | 2328 |
| 1600                | 1104 | 1400 | 1678 | 1939 | 2187 | 2660 |
| 1800                | 1242 | 1575 | 1888 | 2182 | 2460 | 2993 |
| 2000                | 1380 | 1750 | 2098 | 2424 | 2733 | 3326 |
| 2200                | 1518 | 1925 | 2307 | 2667 |      |      |
| 2400                | 1656 | 2100 | 2517 | 2909 |      |      |
| 2600                | 1795 | 2275 | 2727 | 3152 |      |      |
| 2800                | 1933 | 2450 | 2937 |      |      |      |
| 3000                | 2071 | 2625 | 3147 |      |      |      |

CENTRAL DESIGN

TYPE 21s Watts 75/65/20 conform EN442-1: 2014: radiatoren en convectoren

| Hoogte (mm)         | 300  | 400  | 500  | 600  | 700  | 900  |
|---------------------|------|------|------|------|------|------|
| W/m 75/65/20 (φ50K) | 690  | 868  | 1034 | 1192 | 1342 | 1623 |
| n-exponent          | 1,28 | 1,29 | 1,29 | 1,30 | 1,30 | 1,29 |
| Lengte (mm)         | Watt | Watt | Watt | Watt | Watt | Watt |
| 400                 |      | 347  | 414  | 477  | 537  |      |
| 500                 |      |      |      |      | 671  | 812  |
| 600                 |      | 521  | 620  | 715  | 805  | 974  |
| 700                 |      |      |      |      | 939  | 1136 |
| 800                 |      | 694  | 827  | 954  | 1074 | 1298 |
| 900                 |      |      |      |      | 1208 | 1461 |
| 1000                | 690  | 868  | 1034 | 1192 | 1342 |      |
| 1200                | 828  |      | 1241 | 1430 | 1610 |      |
| 1400                | 966  | 1215 | 1448 | 1669 |      |      |
| 1600                | 1104 | 1389 | 1654 | 1907 |      |      |
| 1800                | 1242 | 1562 | 1861 | 2146 |      |      |
| 2000                | 1380 | 1736 | 2068 | 2384 |      |      |
| 2400                |      |      | 2482 | 2861 |      |      |

TYPE 21s Watts 70/55/20 conform EN442-1: 2014: radiatoren en convectoren

| Hoogte (mm)           | 300  | 400  | 500  | 600  | 700  | 900  |
|-----------------------|------|------|------|------|------|------|
| W/m 70/55/20 (φ42,5K) | 560  | 704  | 838  | 965  | 1086 | 1316 |
| n-exponent            | 1,28 | 1,29 | 1,29 | 1,30 | 1,30 | 1,29 |
| Lengte (mm)           | Watt | Watt | Watt | Watt | Watt | Watt |
| 400                   |      | 282  | 335  | 386  | 435  |      |
| 500                   |      |      |      |      | 543  | 658  |
| 600                   |      | 422  | 503  | 579  | 652  | 790  |
| 700                   |      |      |      |      | 760  | 921  |
| 800                   |      | 563  | 671  | 772  | 869  | 1053 |
| 900                   |      |      |      |      | 978  | 1184 |
| 1000                  | 560  | 704  | 838  | 965  | 1086 |      |
| 1200                  | 672  |      | 1006 | 1158 | 1304 |      |
| 1400                  | 785  | 985  | 1174 | 1351 |      |      |
| 1600                  | 897  | 1126 | 1342 | 1544 |      |      |
| 1800                  | 1009 | 1267 | 1509 | 1737 |      |      |
| 2000                  | 1121 | 1408 | 1677 | 1930 |      |      |
| 2400                  |      |      | 2012 | 2316 |      |      |

TYPE 21s Watts 55/45/20 conform EN442-1: 2014: radiatoren en convectoren

| Hoogte (mm)         | 300  | 400  | 500  | 600  | 700  | 900  |
|---------------------|------|------|------|------|------|------|
| W/m 55/45/20 (φ30K) | 359  | 449  | 535  | 614  | 691  | 840  |
| n-exponent          | 1,28 | 1,29 | 1,29 | 1,30 | 1,30 | 1,29 |
| Lengte (mm)         | Watt | Watt | Watt | Watt | Watt | Watt |
| 400                 |      | 180  | 214  | 245  | 276  |      |
| 500                 |      |      |      |      | 345  | 420  |
| 600                 |      | 269  | 321  | 368  | 414  | 504  |
| 700                 |      |      |      |      | 484  | 588  |
| 800                 |      | 359  | 428  | 491  | 553  | 672  |
| 900                 |      |      |      |      | 622  | 756  |
| 1000                | 359  | 449  | 535  | 614  | 691  |      |
| 1200                | 431  |      | 642  | 736  | 829  |      |
| 1400                | 502  | 629  | 749  | 859  |      |      |
| 1600                | 574  | 719  | 856  | 982  |      |      |
| 1800                | 646  | 808  | 963  | 1104 |      |      |
| 2000                | 718  | 898  | 1070 | 1227 |      |      |
| 2400                |      |      | 1284 | 1473 |      |      |



## CENTRAL DESIGN

**TYPE 22** Watts 75/65/20 conform EN442-1: 2014: radiatoren en convectoren

| Hoogte (mm)         | 300  | 400  | 500  | 600  | 700  | 900  |
|---------------------|------|------|------|------|------|------|
| W/m 75/65/20 (φ50K) | 878  | 1104 | 1317 | 1521 | 1717 | 2089 |
| n-exponent          | 1,30 | 1,30 | 1,31 | 1,31 | 1,30 | 1,28 |
| Lengte (mm)         | Watt | Watt | Watt | Watt | Watt | Watt |
| 400                 |      | 442  |      | 608  | 687  | 836  |
| 500                 |      |      |      | 761  | 859  | 1045 |
| 600                 | 527  | 662  | 790  | 913  | 1030 | 1253 |
| 700                 |      |      |      | 1065 | 1202 | 1462 |
| 800                 | 702  | 883  | 1054 | 1217 | 1374 | 1671 |
| 900                 |      |      |      | 1369 |      | 1880 |
| 1000                | 878  | 1104 | 1317 | 1521 | 1717 | 2089 |
| 1200                | 1054 | 1325 | 1580 | 1825 | 2060 | 2507 |
| 1400                | 1229 | 1546 | 1844 | 2129 |      |      |
| 1600                | 1405 | 1766 | 2107 | 2434 |      |      |
| 1800                | 1580 | 1987 | 2371 | 2738 |      |      |
| 2000                | 1756 | 2208 | 2634 | 3042 |      |      |
| 2400                | 2107 | 2650 | 3161 | 3650 |      |      |
| 3000                | 2634 | 3312 | 3951 | 4563 |      |      |

**TYPE 22** Watts 70/55/20 conform EN442-1: 2014: radiatoren en convectoren

| Hoogte (mm)           | 300  | 400  | 500  | 600  | 700  | 900  |
|-----------------------|------|------|------|------|------|------|
| W/m 70/55/20 (φ42,5K) | 711  | 894  | 1064 | 1229 | 1390 | 1697 |
| n-exponent            | 1,30 | 1,30 | 1,31 | 1,31 | 1,30 | 1,28 |
| Lengte (mm)           | Watt | Watt | Watt | Watt | Watt | Watt |
| 400                   |      | 357  |      | 492  | 556  | 679  |
| 500                   |      |      |      | 615  | 695  | 848  |
| 600                   | 426  | 536  | 639  | 738  | 834  | 1018 |
| 700                   |      |      |      | 861  | 973  | 1188 |
| 800                   | 569  | 715  | 852  | 983  | 1112 | 1357 |
| 900                   |      |      |      | 1106 |      | 1527 |
| 1000                  | 711  | 894  | 1064 | 1229 | 1390 | 1697 |
| 1200                  | 853  | 1072 | 1277 | 1475 | 1668 | 2036 |
| 1400                  | 995  | 1251 | 1490 | 1721 |      |      |
| 1600                  | 1137 | 1430 | 1703 | 1967 |      |      |
| 1800                  | 1279 | 1609 | 1916 | 2213 |      |      |
| 2000                  | 1422 | 1787 | 2129 | 2459 |      |      |
| 2400                  | 1706 | 2145 | 2555 | 2950 |      |      |
| 3000                  | 2132 | 2681 | 3193 | 3688 |      |      |

**TYPE 22** Watts 55/45/20 conform EN442-1: 2014: radiatoren en convectoren

| Hoogte (mm)         | 300  | 400  | 500  | 600  | 700  | 900  |
|---------------------|------|------|------|------|------|------|
| W/m 55/45/20 (φ30K) | 452  | 568  | 674  | 779  | 884  | 1086 |
| n-exponent          | 1,30 | 1,30 | 1,31 | 1,31 | 1,30 | 1,28 |
| Lengte (mm)         | Watt | Watt | Watt | Watt | Watt | Watt |
| 400                 |      | 227  |      | 312  | 354  | 435  |
| 500                 |      |      |      | 389  | 442  | 543  |
| 600                 | 271  | 341  | 405  | 467  | 530  | 652  |
| 700                 |      |      |      | 545  | 619  | 760  |
| 800                 | 362  | 455  | 540  | 623  | 707  | 869  |
| 900                 |      |      |      | 701  |      | 978  |
| 1000                | 452  | 568  | 674  | 779  | 884  | 1086 |
| 1200                | 542  | 682  | 809  | 935  | 1061 | 1304 |
| 1400                | 633  | 796  | 944  | 1091 |      |      |
| 1600                | 723  | 909  | 1079 | 1246 |      |      |
| 1800                | 814  | 1023 | 1214 | 1402 |      |      |
| 2000                | 904  | 1137 | 1349 | 1558 |      |      |
| 2400                | 1085 | 1364 | 1619 | 1869 |      |      |
| 3000                | 1356 | 1705 | 2023 | 2337 |      |      |

CENTRAL DESIGN

TYPE 33 Watts 75/65/20 conform EN442-1: 2014: radiatoren en convectoren

| Hoogte (mm)         | 300  | 400  | 500  | 600  | 700  | 900  |
|---------------------|------|------|------|------|------|------|
| W/m 75/65/20 (φ50K) | 1236 | 1532 | 1822 | 2110 | 2399 | 2991 |
| n-exponent          | 1,32 | 1,32 | 1,32 | 1,32 | 1,32 | 1,32 |
| Lengte (mm)         | Watt | Watt | Watt | Watt | Watt | Watt |
| 400                 |      |      |      |      |      | 1196 |
| 500                 |      |      |      |      | 1200 | 1496 |
| 600                 |      |      |      | 1266 | 1439 | 1795 |
| 700                 |      |      |      | 1477 | 1679 | 2094 |
| 800                 |      |      | 1458 | 1688 | 1919 | 2393 |
| 900                 |      |      |      | 1899 | 2159 | 2692 |
| 1000                |      |      | 1822 | 2110 | 2399 | 2991 |
| 1200                | 1483 | 1838 | 2186 | 2532 | 2879 | 3589 |
| 1400                | 1730 | 2145 | 2551 | 2954 |      | 4187 |
| 1600                | 1978 | 2451 | 2915 | 3376 |      |      |
| 1800                | 2225 | 2758 |      | 3798 |      |      |
| 2000                | 2472 | 3064 | 3644 | 4220 |      |      |

TYPE 33 Watts 70/55/20 conform EN442-1: 2014: radiatoren en convectoren

| Hoogte (mm)           | 300  | 400  | 500  | 600  | 700  | 900  |
|-----------------------|------|------|------|------|------|------|
| W/m 70/55/20 (φ42,5K) | 997  | 1236 | 1470 | 1703 | 1936 | 2414 |
| n-exponent            | 1,32 | 1,32 | 1,32 | 1,32 | 1,32 | 1,32 |
| Lengte (mm)           | Watt | Watt | Watt | Watt | Watt | Watt |
| 400                   |      |      |      |      |      | 965  |
| 500                   |      |      |      |      | 968  | 1207 |
| 600                   |      |      |      | 1022 | 1161 | 1448 |
| 700                   |      |      |      | 1192 | 1355 | 1689 |
| 800                   |      |      | 1176 | 1362 | 1549 | 1931 |
| 900                   |      |      |      | 1532 | 1742 | 2172 |
| 1000                  |      |      | 1470 | 1703 | 1936 | 2414 |
| 1200                  | 1197 | 1483 | 1764 | 2043 | 2323 | 2896 |
| 1400                  | 1396 | 1731 | 2058 | 2384 |      | 3379 |
| 1600                  | 1596 | 1978 | 2352 | 2724 |      |      |
| 1800                  | 1795 | 2225 |      | 3065 |      |      |
| 2000                  | 1995 | 2472 | 2940 | 3405 |      |      |

TYPE 33 Watts 55/45/20 conform EN442-1: 2014: radiatoren en convectoren

| Hoogte (mm)         | 300  | 400  | 500  | 600  | 700  | 900  |
|---------------------|------|------|------|------|------|------|
| W/m 55/45/20 (φ30K) | 630  | 781  | 928  | 1075 | 1222 | 1524 |
| n-exponent          | 1,32 | 1,32 | 1,32 | 1,32 | 1,32 | 1,32 |
| Lengte (mm)         | Watt | Watt | Watt | Watt | Watt | Watt |
| 400                 |      |      |      |      |      | 610  |
| 500                 |      |      |      |      | 611  | 762  |
| 600                 |      |      |      | 645  | 733  | 914  |
| 700                 |      |      |      | 753  | 856  | 1067 |
| 800                 |      |      | 743  | 860  | 978  | 1219 |
| 900                 |      |      |      | 968  | 1100 | 1372 |
| 1000                |      |      | 928  | 1075 | 1222 | 1524 |
| 1200                | 756  | 937  | 1114 | 1290 | 1467 | 1829 |
| 1400                | 882  | 1093 | 1300 | 1505 |      | 2134 |
| 1600                | 1008 | 1249 | 1485 | 1720 |      |      |
| 1800                | 1134 | 1405 |      | 1935 |      |      |
| 2000                | 1260 | 1561 | 1857 | 2150 |      |      |

## CENTRAL LINE

TYPE 21s Watts 75/65/20 conform EN442-1: 2014: radiatoren en convectoren

| Hoogte (mm)         | 300  | 400  | 500  | 600  | 700  | 900  |
|---------------------|------|------|------|------|------|------|
| W/m 75/65/20 (φ50K) | 690  | 868  | 1034 | 1192 | 1342 | 1623 |
| n-exponent          | 1,28 | 1,29 | 1,29 | 1,30 | 1,30 | 1,29 |
| Lengte (mm)         | Watt | Watt | Watt | Watt | Watt | Watt |
| 400                 |      | 347  | 414  | 477  | 537  |      |
| 500                 |      |      |      |      | 671  | 812  |
| 600                 |      | 521  | 620  | 715  | 805  | 974  |
| 700                 |      |      |      |      | 939  | 1136 |
| 800                 |      | 694  | 827  | 954  | 1074 | 1298 |
| 900                 |      |      |      |      | 1208 | 1461 |
| 1000                | 690  | 868  | 1034 | 1192 | 1342 |      |
| 1200                | 828  |      | 1241 | 1430 | 1610 |      |
| 1400                | 966  | 1215 | 1448 | 1669 |      |      |
| 1600                | 1104 | 1389 | 1654 | 1907 |      |      |
| 1800                | 1242 | 1562 | 1861 | 2146 |      |      |
| 2000                | 1380 | 1736 | 2068 | 2384 |      |      |
| 2400                |      |      | 2482 | 2861 |      |      |

TYPE 21s Watts 70/55/20 conform EN442-1: 2014: radiatoren en convectoren

| Hoogte (mm)           | 300  | 400  | 500  | 600  | 700  | 900  |
|-----------------------|------|------|------|------|------|------|
| W/m 70/55/20 (φ42,5K) | 560  | 704  | 838  | 965  | 1086 | 1316 |
| n-exponent            | 1,28 | 1,29 | 1,29 | 1,30 | 1,30 | 1,29 |
| Lengte (mm)           | Watt | Watt | Watt | Watt | Watt | Watt |
| 400                   |      | 282  | 335  | 386  | 435  |      |
| 500                   |      |      |      |      | 543  | 658  |
| 600                   |      | 422  | 503  | 579  | 652  | 790  |
| 700                   |      |      |      |      | 760  | 921  |
| 800                   |      | 563  | 671  | 772  | 869  | 1053 |
| 900                   |      |      |      |      | 978  | 1184 |
| 1000                  | 560  | 704  | 838  | 965  | 1086 |      |
| 1200                  | 672  |      | 1006 | 1158 | 1304 |      |
| 1400                  | 785  | 985  | 1174 | 1351 |      |      |
| 1600                  | 897  | 1126 | 1342 | 1544 |      |      |
| 1800                  | 1009 | 1267 | 1509 | 1737 |      |      |
| 2000                  | 1121 | 1408 | 1677 | 1930 |      |      |
| 2400                  |      |      | 2012 | 2316 |      |      |

TYPE 21s Watts 55/45/20 conform EN442-1: 2014: radiatoren en convectoren

| Hoogte (mm)         | 300  | 400  | 500  | 600  | 700  | 900  |
|---------------------|------|------|------|------|------|------|
| W/m 55/45/20 (φ30K) | 359  | 449  | 535  | 614  | 691  | 840  |
| n-exponent          | 1,28 | 1,29 | 1,29 | 1,30 | 1,30 | 1,29 |
| Lengte (mm)         | Watt | Watt | Watt | Watt | Watt | Watt |
| 400                 |      | 180  | 214  | 245  | 276  |      |
| 500                 |      |      |      |      | 345  | 420  |
| 600                 |      | 269  | 321  | 368  | 414  | 504  |
| 700                 |      |      |      |      | 484  | 588  |
| 800                 |      | 359  | 428  | 491  | 553  | 672  |
| 900                 |      |      |      |      | 622  | 756  |
| 1000                | 359  | 449  | 535  | 614  | 691  |      |
| 1200                | 431  |      | 642  | 736  | 829  |      |
| 1400                | 502  | 629  | 749  | 859  |      |      |
| 1600                | 574  | 719  | 856  | 982  |      |      |
| 1800                | 646  | 808  | 963  | 1104 |      |      |
| 2000                | 718  | 898  | 1070 | 1227 |      |      |
| 2400                |      |      | 1284 | 1473 |      |      |

CENTRAL LINE

TYPE 22 Watts 75/65/20 conform EN442-1: 2014: radiatoren en convectoren

| Hoogte (mm)         | 300  | 400  | 500  | 600  | 700  | 900  |
|---------------------|------|------|------|------|------|------|
| W/m 75/65/20 (φ50K) | 878  | 1104 | 1317 | 1521 | 1717 | 2089 |
| n-exponent          | 1,30 | 1,30 | 1,31 | 1,31 | 1,30 | 1,28 |
| Lengte (mm)         | Watt | Watt | Watt | Watt | Watt | Watt |
| 400                 |      | 442  |      | 608  | 687  | 836  |
| 500                 |      |      |      | 761  | 859  | 1045 |
| 600                 | 527  | 662  | 790  | 913  | 1030 | 1253 |
| 700                 |      |      |      | 1065 | 1202 | 1462 |
| 800                 | 702  | 883  | 1054 | 1217 | 1374 | 1671 |
| 900                 |      |      |      | 1369 |      | 1880 |
| 1000                | 878  | 1104 | 1317 | 1521 | 1717 | 2089 |
| 1200                | 1054 | 1325 | 1580 | 1825 | 2060 | 2507 |
| 1400                | 1229 | 1546 | 1844 | 2129 |      |      |
| 1600                | 1405 | 1766 | 2107 | 2434 |      |      |
| 1800                | 1580 | 1987 | 2371 | 2738 |      |      |
| 2000                | 1756 | 2208 | 2634 | 3042 |      |      |
| 2400                | 2107 | 2650 | 3161 | 3650 |      |      |
| 3000                | 2634 | 3312 | 3951 | 4563 |      |      |

TYPE 22 Watts 70/55/20 conform EN442-1: 2014: radiatoren en convectoren

| Hoogte (mm)           | 300  | 400  | 500  | 600  | 700  | 900  |
|-----------------------|------|------|------|------|------|------|
| W/m 70/55/20 (φ42,5K) | 711  | 894  | 1064 | 1229 | 1390 | 1697 |
| n-exponent            | 1,30 | 1,30 | 1,31 | 1,31 | 1,30 | 1,28 |
| Lengte (mm)           | Watt | Watt | Watt | Watt | Watt | Watt |
| 400                   |      | 357  |      | 492  | 556  | 679  |
| 500                   |      |      |      | 615  | 695  | 848  |
| 600                   | 426  | 536  | 639  | 738  | 834  | 1018 |
| 700                   |      |      |      | 861  | 973  | 1188 |
| 800                   | 569  | 715  | 852  | 983  | 1112 | 1357 |
| 900                   |      |      |      | 1106 |      | 1527 |
| 1000                  | 711  | 894  | 1064 | 1229 | 1390 | 1697 |
| 1200                  | 853  | 1072 | 1277 | 1475 | 1668 | 2036 |
| 1400                  | 995  | 1251 | 1490 | 1721 |      |      |
| 1600                  | 1137 | 1430 | 1703 | 1967 |      |      |
| 1800                  | 1279 | 1609 | 1916 | 2213 |      |      |
| 2000                  | 1422 | 1787 | 2129 | 2459 |      |      |
| 2400                  | 1706 | 2145 | 2555 | 2950 |      |      |
| 3000                  | 2132 | 2681 | 3193 | 3688 |      |      |

TYPE 22 Watts 55/45/20 conform EN442-1: 2014: radiatoren en convectoren

| Hoogte (mm)         | 300  | 400  | 500  | 600  | 700  | 900  |
|---------------------|------|------|------|------|------|------|
| W/m 55/45/20 (φ30K) | 452  | 568  | 674  | 779  | 884  | 1086 |
| n-exponent          | 1,30 | 1,30 | 1,31 | 1,31 | 1,30 | 1,28 |
| Lengte (mm)         | Watt | Watt | Watt | Watt | Watt | Watt |
| 400                 |      | 227  |      | 312  | 354  | 435  |
| 500                 |      |      |      | 389  | 442  | 543  |
| 600                 | 271  | 341  | 405  | 467  | 530  | 652  |
| 700                 |      |      |      | 545  | 619  | 760  |
| 800                 | 362  | 455  | 540  | 623  | 707  | 869  |
| 900                 |      |      |      | 701  |      | 978  |
| 1000                | 452  | 568  | 674  | 779  | 884  | 1086 |
| 1200                | 542  | 682  | 809  | 935  | 1061 | 1304 |
| 1400                | 633  | 796  | 944  | 1091 |      |      |
| 1600                | 723  | 909  | 1079 | 1246 |      |      |
| 1800                | 814  | 1023 | 1214 | 1402 |      |      |
| 2000                | 904  | 1137 | 1349 | 1558 |      |      |
| 2400                | 1085 | 1364 | 1619 | 1869 |      |      |
| 3000                | 1356 | 1705 | 2023 | 2337 |      |      |

## CENTRAL LINE

**TYPE 33** Watts 75/65/20 conform EN442-1: 2014: radiatoren en convectoren

| Hoogte (mm)         | 300  | 400  | 500  | 600  | 700  | 900  |
|---------------------|------|------|------|------|------|------|
| W/m 75/65/20 (φ50K) | 1236 | 1532 | 1822 | 2110 | 2399 | 2991 |
| n-exponent          | 1,32 | 1,32 | 1,32 | 1,32 | 1,32 | 1,32 |
| Lengte (mm)         | Watt | Watt | Watt | Watt | Watt | Watt |
| 400                 |      |      |      |      |      | 1196 |
| 500                 |      |      |      |      | 1200 | 1496 |
| 600                 |      |      |      | 1266 | 1439 | 1795 |
| 700                 |      |      |      | 1477 | 1679 | 2094 |
| 800                 | 989  |      | 1458 | 1688 | 1919 | 2393 |
| 900                 |      |      |      | 1899 |      | 2692 |
| 1000                | 1236 |      | 1822 | 2110 | 2399 | 2991 |
| 1200                | 1483 | 1838 | 2186 | 2532 | 2879 | 3589 |
| 1400                | 1730 | 2145 | 2551 | 2954 |      | 4187 |
| 1600                | 1978 | 2451 | 2915 | 3376 |      |      |
| 1800                | 2225 | 2758 |      | 3798 |      |      |
| 2000                | 2472 | 3064 | 3644 | 4220 |      |      |

**TYPE 33** Watts 70/55/20 conform EN442-1: 2014: radiatoren en convectoren

| Hoogte (mm)           | 300  | 400  | 500  | 600  | 700  | 900  |
|-----------------------|------|------|------|------|------|------|
| W/m 70/55/20 (φ42,5K) | 997  | 1236 | 1470 | 1703 | 1936 | 2414 |
| n-exponent            | 1,32 | 1,32 | 1,32 | 1,32 | 1,32 | 1,32 |
| Lengte (mm)           | Watt | Watt | Watt | Watt | Watt | Watt |
| 400                   |      |      |      |      |      | 965  |
| 500                   |      |      |      |      | 968  | 1207 |
| 600                   |      |      |      | 1022 | 1161 | 1448 |
| 700                   |      |      |      | 1192 | 1355 | 1689 |
| 800                   | 798  |      | 1176 | 1362 | 1549 | 1931 |
| 900                   |      |      |      | 1532 |      | 2172 |
| 1000                  | 997  |      | 1470 | 1703 | 1936 | 2414 |
| 1200                  | 1197 | 1483 | 1764 | 2043 | 2323 | 2896 |
| 1400                  | 1396 | 1731 | 2058 | 2384 |      | 3379 |
| 1600                  | 1596 | 1978 | 2352 | 2724 |      |      |
| 1800                  | 1795 | 2225 |      | 3065 |      |      |
| 2000                  | 1995 | 2472 | 2940 | 3405 |      |      |

**TYPE 33** Watts 55/45/20 conform EN442-1: 2014: radiatoren en convectoren

| Hoogte (mm)         | 300  | 400  | 500  | 600  | 700  | 900  |
|---------------------|------|------|------|------|------|------|
| W/m 55/45/20 (φ30K) | 630  | 781  | 928  | 1075 | 1222 | 1524 |
| n-exponent          | 1,32 | 1,32 | 1,32 | 1,32 | 1,32 | 1,32 |
| Lengte (mm)         | Watt | Watt | Watt | Watt | Watt | Watt |
| 400                 |      |      |      |      |      | 610  |
| 500                 |      |      |      |      | 611  | 762  |
| 600                 |      |      |      | 645  | 733  | 914  |
| 700                 |      |      |      | 753  | 856  | 1067 |
| 800                 | 504  |      | 743  | 860  | 978  | 1219 |
| 900                 |      |      |      | 968  |      | 1372 |
| 1000                | 630  |      | 928  | 1075 | 1222 | 1524 |
| 1200                | 756  | 937  | 1114 | 1290 | 1467 | 1829 |
| 1400                | 882  | 1093 | 1300 | 1505 |      | 2134 |
| 1600                | 1008 | 1249 | 1485 | 1720 |      |      |
| 1800                | 1134 | 1405 |      | 1935 |      |      |
| 2000                | 1260 | 1561 | 1857 | 2150 |      |      |



# Verticale

## RADIATOREN



VERTI M KOMPAKT (GALVA)

TYPE 21s Watts 75/65/20 conform EN442-1: 2014: radiatoren en convectoren

| Hoogte (mm)         | 1600 | 1800 | 2000 | 2200 |
|---------------------|------|------|------|------|
| W/m 75/65/20 (φ50K) | 2962 | 3242 | 3516 | 3782 |
| n-exponent          | 1,35 | 1,34 | 1,32 | 1,36 |
| Lengte (mm)         | Watt | Watt | Watt | Watt |
| 400                 | 1185 | 1297 | 1406 | 1513 |
| 500                 | 1481 | 1621 | 1758 | 1891 |
| 600                 | 1777 | 1945 | 2110 | 2269 |
| 700                 | 2073 | 2269 | 2461 | 2647 |
| 800                 | 2370 | 2594 | 2813 | 3026 |

TYPE 21s Watts 70/55/20 conform EN442-1: 2014: radiatoren en convectoren

| Hoogte (mm)           | 1600 | 1800 | 2000 | 2200 |
|-----------------------|------|------|------|------|
| W/m 70/55/20 (φ42,5K) | 2378 | 2608 | 2837 | 3032 |
| n-exponent            | 1,35 | 1,34 | 1,32 | 1,36 |
| Lengte (mm)           | Watt | Watt | Watt | Watt |
| 400                   | 951  | 1043 | 1135 | 1213 |
| 500                   | 1189 | 1304 | 1419 | 1516 |
| 600                   | 1427 | 1565 | 1702 | 1819 |
| 700                   | 1665 | 1826 | 1986 | 2122 |
| 800                   | 1902 | 2086 | 2270 | 2426 |

TYPE 21s Watts 55/45/20 conform EN442-1: 2014: radiatoren en convectoren

| Hoogte (mm)         | 1600 | 1800 | 2000 | 2200 |
|---------------------|------|------|------|------|
| W/m 55/45/20 (φ30K) | 1486 | 1635 | 1791 | 1888 |
| n-exponent          | 1,35 | 1,34 | 1,32 | 1,36 |
| Lengte (mm)         | Watt | Watt | Watt | Watt |
| 400                 | 594  | 654  | 716  | 755  |
| 500                 | 743  | 818  | 896  | 944  |
| 600                 | 892  | 981  | 1075 | 1133 |
| 700                 | 1040 | 1145 | 1254 | 1322 |
| 800                 | 1189 | 1308 | 1433 | 1510 |

TYPE 22 Watts 75/65/20 conform EN442-1: 2014: radiatoren en convectoren

| Hoogte (mm)         | 1600 | 1800 | 2000 | 2200 |
|---------------------|------|------|------|------|
| W/m 75/65/20 (φ50K) | 3608 | 3896 | 4190 | 4488 |
| n-exponent          | 1,38 | 1,36 | 1,33 | 1,45 |
| Lengte (mm)         | Watt | Watt | Watt | Watt |
| 400                 | 1443 | 1558 | 1676 | 1795 |
| 500                 | 1804 | 1948 | 2095 | 2244 |
| 600                 | 2165 | 2338 | 2514 | 2693 |
| 700                 | 2526 | 2727 | 2933 | 3142 |
| 800                 | 2886 | 3117 | 3352 | 3590 |

TYPE 22 Watts 70/55/20 conform EN442-1: 2014: radiatoren en convectoren

| Hoogte (mm)           | 1600 | 1800 | 2000 | 2200 |
|-----------------------|------|------|------|------|
| W/m 70/55/20 (φ42,5K) | 2883 | 3123 | 3376 | 3546 |
| n-exponent            | 1,38 | 1,36 | 1,33 | 1,45 |
| Lengte (mm)           | Watt | Watt | Watt | Watt |
| 400                   | 1153 | 1249 | 1350 | 1418 |
| 500                   | 1442 | 1562 | 1688 | 1773 |
| 600                   | 1730 | 1874 | 2026 | 2128 |
| 700                   | 2018 | 2186 | 2363 | 2482 |
| 800                   | 2306 | 2498 | 2701 | 2837 |

TYPE 22 Watts 55/45/20 conform EN442-1: 2014: radiatoren en convectoren

| Hoogte (mm)         | 1600 | 1800 | 2000 | 2200 |
|---------------------|------|------|------|------|
| W/m 55/45/20 (φ30K) | 1783 | 1945 | 2124 | 2140 |
| n-exponent          | 1,38 | 1,36 | 1,33 | 1,45 |
| Lengte (mm)         | Watt | Watt | Watt | Watt |
| 400                 | 713  | 778  | 850  | 856  |
| 500                 | 892  | 973  | 1062 | 1070 |
| 600                 | 1070 | 1167 | 1274 | 1284 |
| 700                 | 1248 | 1362 | 1487 | 1498 |
| 800                 | 1426 | 1556 | 1699 | 1712 |



## VERTI M DESIGN

TYPE 21s Watts 75/65/20 conform EN442-1: 2014: radiatoren en convectoren

| Hoogte (mm)         | 1600 | 1800 | 2000 | 2200 |
|---------------------|------|------|------|------|
| W/m 75/65/20 (φ50K) | 2618 | 2800 | 2996 | 3208 |
| n-exponent          | 1,33 | 1,35 | 1,36 | 1,46 |
| Lengte (mm)         | Watt | Watt | Watt | Watt |
| 400                 | 1047 | 1120 | 1198 | 1283 |
| 500                 | 1309 | 1400 | 1498 | 1604 |
| 600                 | 1571 | 1680 | 1798 | 1925 |
| 700                 | 1833 | 1960 | 2097 | 2246 |
| 800                 | 2094 | 2240 | 2397 | 2566 |

TYPE 21s Watts 70/55/20 conform EN442-1: 2014: radiatoren en convectoren

| Hoogte (mm)           | 1600 | 1800 | 2000 | 2200 |
|-----------------------|------|------|------|------|
| W/m 70/55/20 (φ42,5K) | 2109 | 2248 | 2402 | 2530 |
| n-exponent            | 1,33 | 1,35 | 1,36 | 1,46 |
| Lengte (mm)           | Watt | Watt | Watt | Watt |
| 400                   | 844  | 899  | 961  | 1012 |
| 500                   | 1055 | 1124 | 1201 | 1265 |
| 600                   | 1265 | 1349 | 1441 | 1518 |
| 700                   | 1476 | 1574 | 1681 | 1771 |
| 800                   | 1687 | 1798 | 1922 | 2024 |

TYPE 21s Watts 55/45/20 conform EN442-1: 2014: radiatoren en convectoren

| Hoogte (mm)         | 1600 | 1800 | 2000 | 2200 |
|---------------------|------|------|------|------|
| W/m 55/45/20 (φ30K) | 1327 | 1405 | 1496 | 1522 |
| n-exponent          | 1,33 | 1,35 | 1,36 | 1,46 |
| Lengte (mm)         | Watt | Watt | Watt | Watt |
| 400                 | 531  | 562  | 598  | 609  |
| 500                 | 664  | 703  | 748  | 761  |
| 600                 | 796  | 843  | 898  | 913  |
| 700                 | 929  | 984  | 1047 | 1065 |
| 800                 | 1062 | 1124 | 1197 | 1218 |

TYPE 22 Watts 75/65/20 conform EN442-1: 2014: radiatoren en convectoren

| Hoogte (mm)         | 1600 | 1800 | 2000 | 2200 |
|---------------------|------|------|------|------|
| W/m 75/65/20 (φ50K) | 3202 | 3486 | 3772 | 4064 |
| n-exponent          | 1,40 | 1,44 | 1,48 | 1,35 |
| Lengte (mm)         | Watt | Watt | Watt | Watt |
| 400                 | 1281 | 1394 | 1509 | 1626 |
| 500                 | 1601 | 1743 | 1886 | 2032 |
| 600                 | 1921 | 2092 | 2263 | 2438 |
| 700                 | 2241 | 2440 | 2640 | 2845 |
| 800                 | 2562 | 2789 | 3018 | 3251 |

TYPE 22 Watts 70/55/20 conform EN442-1: 2014: radiatoren en convectoren

| Hoogte (mm)           | 1600 | 1800 | 2000 | 2200 |
|-----------------------|------|------|------|------|
| W/m 70/55/20 (φ42,5K) | 2550 | 2759 | 2966 | 3263 |
| n-exponent            | 1,40 | 1,44 | 1,48 | 1,35 |
| Lengte (mm)           | Watt | Watt | Watt | Watt |
| 400                   | 1020 | 1104 | 1186 | 1305 |
| 500                   | 1275 | 1380 | 1483 | 1632 |
| 600                   | 1530 | 1655 | 1780 | 1958 |
| 700                   | 1785 | 1931 | 2076 | 2284 |
| 800                   | 2040 | 2207 | 2373 | 2610 |

TYPE 22 Watts 55/45/20 conform EN442-1: 2014: radiatoren en convectoren

| Hoogte (mm)         | 1600 | 1800 | 2000 | 2200 |
|---------------------|------|------|------|------|
| W/m 55/45/20 (φ30K) | 1566 | 1671 | 1771 | 2039 |
| n-exponent          | 1,40 | 1,44 | 1,48 | 1,35 |
| Lengte (mm)         | Watt | Watt | Watt | Watt |
| 400                 | 626  | 668  | 708  | 816  |
| 500                 | 783  | 836  | 886  | 1020 |
| 600                 | 940  | 1003 | 1063 | 1223 |
| 700                 | 1096 | 1170 | 1240 | 1427 |
| 800                 | 1253 | 1337 | 1417 | 1631 |

VERTI M LINE

TYPE 21s Watts 75/65/20 conform EN442-1: 2014: radiatoren en convectoren

| Hoogte (mm)         | 1600 | 1800 | 2000 | 2200 |
|---------------------|------|------|------|------|
| W/m 75/65/20 (φ50K) | 2618 | 2800 | 2996 | 3208 |
| n-exponent          | 1,33 | 1,35 | 1,36 | 1,46 |
| Lengte (mm)         | Watt | Watt | Watt | Watt |
| 400                 | 1047 | 1120 | 1198 | 1283 |
| 500                 | 1309 | 1400 | 1498 | 1604 |
| 600                 | 1571 | 1680 | 1798 | 1925 |
| 700                 | 1833 | 1960 | 2097 | 2246 |
| 800                 | 2094 | 2240 | 2397 | 2566 |

TYPE 21s Watts 70/55/20 conform EN442-1: 2014: radiatoren en convectoren

| Hoogte (mm)           | 1600 | 1800 | 2000 | 2200 |
|-----------------------|------|------|------|------|
| W/m 70/55/20 (φ42,5K) | 2109 | 2248 | 2402 | 2530 |
| n-exponent            | 1,33 | 1,35 | 1,36 | 1,46 |
| Lengte (mm)           | Watt | Watt | Watt | Watt |
| 400                   | 844  | 899  | 961  | 1012 |
| 500                   | 1055 | 1124 | 1201 | 1265 |
| 600                   | 1265 | 1349 | 1441 | 1518 |
| 700                   | 1476 | 1574 | 1681 | 1771 |
| 800                   | 1687 | 1798 | 1922 | 2024 |

TYPE 21s Watts 55/45/20 conform EN442-1: 2014: radiatoren en convectoren

| Hoogte (mm)         | 1600 | 1800 | 2000 | 2200 |
|---------------------|------|------|------|------|
| W/m 55/45/20 (φ30K) | 1327 | 1405 | 1496 | 1522 |
| n-exponent          | 1,33 | 1,35 | 1,36 | 1,46 |
| Lengte (mm)         | Watt | Watt | Watt | Watt |
| 400                 | 531  | 562  | 598  | 609  |
| 500                 | 664  | 703  | 748  | 761  |
| 600                 | 796  | 843  | 898  | 913  |
| 700                 | 929  | 984  | 1047 | 1065 |
| 800                 | 1062 | 1124 | 1197 | 1218 |

TYPE 22 Watts 75/65/20 conform EN442-1: 2014: radiatoren en convectoren

| Hoogte (mm)         | 1600 | 1800 | 2000 | 2200 |
|---------------------|------|------|------|------|
| W/m 75/65/20 (φ50K) | 3202 | 3486 | 3772 | 4064 |
| n-exponent          | 1,40 | 1,44 | 1,48 | 1,35 |
| Lengte (mm)         | Watt | Watt | Watt | Watt |
| 400                 | 1281 | 1394 | 1509 | 1626 |
| 500                 | 1601 | 1743 | 1886 | 2032 |
| 600                 | 1921 | 2092 | 2263 | 2438 |
| 700                 | 2241 | 2440 | 2640 | 2845 |
| 800                 | 2562 | 2789 | 3018 | 3251 |

TYPE 22 Watts 70/55/20 conform EN442-1: 2014: radiatoren en convectoren

| Hoogte (mm)           | 1600 | 1800 | 2000 | 2200 |
|-----------------------|------|------|------|------|
| W/m 70/55/20 (φ42,5K) | 2550 | 2759 | 2966 | 3263 |
| n-exponent            | 1,40 | 1,44 | 1,48 | 1,35 |
| Lengte (mm)           | Watt | Watt | Watt | Watt |
| 400                   | 1020 | 1104 | 1186 | 1305 |
| 500                   | 1275 | 1380 | 1483 | 1632 |
| 600                   | 1530 | 1655 | 1780 | 1958 |
| 700                   | 1785 | 1931 | 2076 | 2284 |
| 800                   | 2040 | 2207 | 2373 | 2610 |

TYPE 22 Watts 55/45/20 conform EN442-1: 2014: radiatoren en convectoren

| Hoogte (mm)         | 1600 | 1800 | 2000 | 2200 |
|---------------------|------|------|------|------|
| W/m 55/45/20 (φ30K) | 1566 | 1671 | 1771 | 2039 |
| n-exponent          | 1,40 | 1,44 | 1,48 | 1,35 |
| Lengte (mm)         | Watt | Watt | Watt | Watt |
| 400                 | 626  | 668  | 708  | 816  |
| 500                 | 783  | 836  | 886  | 1020 |
| 600                 | 940  | 1003 | 1063 | 1223 |
| 700                 | 1096 | 1170 | 1240 | 1427 |
| 800                 | 1253 | 1337 | 1417 | 1631 |

# Central Verti M LINE





# Mini RADIATOREN

# MINI RADIATOREN | WARMTEAFGIFTES PER TYPE RADIATOR

## STANDAARD

Watts 75/65/20 conform EN442-1: 2014: radiatoren en convectoren

| STANDAARD           | Type 22 |      | Type 33 |      | Type 34 |      |
|---------------------|---------|------|---------|------|---------|------|
| Hoogte (mm)         | 150     | 200  | 150     | 200  | 150     | 200  |
| W/m 75/65/20 (φ50K) | 646     | 769  | 945     | 1112 | 1099    | 1293 |
| n-exponent          | 1,26    | 1,26 | 1,26    | 1,26 | 1,25    | 1,27 |
| Lengte (mm)         | Watt    | Watt | Watt    | Watt | Watt    | Watt |
| 800                 | 517     | 615  | 756     | 890  | 879     | 1034 |
| 900                 | 581     | 692  | 851     | 1001 | 989     | 1164 |
| 1000                | 646     | 769  | 945     | 1112 | 1099    | 1293 |
| 1100                | 711     | 846  | 1040    | 1223 | 1209    | 1422 |
| 1200                | 775     | 923  | 1134    | 1334 | 1319    | 1552 |
| 1300                | 840     | 1000 | 1229    | 1446 | 1429    | 1681 |
| 1400                | 904     | 1077 | 1323    | 1557 | 1539    | 1810 |
| 1500                | 969     | 1154 | 1418    | 1668 | 1649    | 1940 |
| 1600                | 1034    | 1230 | 1512    | 1779 | 1758    | 2069 |
| 1800                | 1163    | 1384 | 1701    | 2002 | 1978    | 2327 |
| 2000                | 1292    | 1538 | 1890    | 2224 | 2198    | 2586 |
| 2200                | 1421    | 1692 | 2079    | 2446 | 2418    | 2845 |
| 2400                | 1550    | 1846 | 2268    | 2669 | 2638    | 3103 |
| 2600                | 1680    | 1999 | 2457    | 2891 | 2857    | 3362 |
| 2800                | 1809    | 2153 | 2646    | 3114 | 3077    | 3620 |
| 3000                | 1938    | 2307 | 2835    | 3336 | 3297    | 3879 |

Watts 70/55/20 conform EN442-1: 2014: radiatoren en convectoren

| STANDAARD             | Type 22 |      | Type 33 |      | Type 34 |      |
|-----------------------|---------|------|---------|------|---------|------|
| Hoogte (mm)           | 150     | 200  | 150     | 200  | 150     | 200  |
| W/m 70/55/20 (φ42,5K) | 526     | 627  | 770     | 906  | 897     | 1052 |
| n-exponent            | 1,26    | 1,26 | 1,26    | 1,26 | 1,25    | 1,27 |
| Lengte (mm)           | Watt    | Watt | Watt    | Watt | Watt    | Watt |
| 800                   | 421     | 501  | 616     | 725  | 718     | 841  |
| 900                   | 474     | 564  | 693     | 815  | 807     | 947  |
| 1000                  | 526     | 627  | 770     | 906  | 897     | 1052 |
| 1100                  | 579     | 689  | 847     | 997  | 987     | 1157 |
| 1200                  | 632     | 752  | 924     | 1087 | 1076    | 1262 |
| 1300                  | 684     | 815  | 1001    | 1178 | 1166    | 1367 |
| 1400                  | 737     | 877  | 1078    | 1269 | 1256    | 1473 |
| 1500                  | 790     | 940  | 1155    | 1359 | 1345    | 1578 |
| 1600                  | 842     | 1003 | 1232    | 1450 | 1435    | 1683 |
| 1800                  | 947     | 1128 | 1386    | 1631 | 1615    | 1893 |
| 2000                  | 1053    | 1253 | 1540    | 1812 | 1794    | 2104 |
| 2200                  | 1158    | 1379 | 1694    | 1993 | 1973    | 2314 |
| 2400                  | 1263    | 1504 | 1848    | 2175 | 2153    | 2524 |
| 2600                  | 1369    | 1629 | 2002    | 2356 | 2332    | 2735 |
| 2800                  | 1474    | 1754 | 2156    | 2537 | 2511    | 2945 |
| 3000                  | 1579    | 1880 | 2310    | 2718 | 2691    | 3156 |

Watts 55/45/20 conform EN442-1: 2014: radiatoren en convectoren

| STANDAARD           | Type 22 |      | Type 33 |      | Type 34 |      |
|---------------------|---------|------|---------|------|---------|------|
| Hoogte (mm)         | 150     | 200  | 150     | 200  | 150     | 200  |
| W/m 55/45/20 (φ30K) | 339     | 404  | 496     | 584  | 580     | 676  |
| n-exponent          | 1,26    | 1,26 | 1,26    | 1,26 | 1,25    | 1,27 |
| Lengte (mm)         | Watt    | Watt | Watt    | Watt | Watt    | Watt |
| 800                 | 272     | 323  | 397     | 467  | 464     | 541  |
| 900                 | 305     | 364  | 447     | 526  | 522     | 608  |
| 1000                | 339     | 404  | 496     | 584  | 580     | 676  |
| 1100                | 373     | 444  | 546     | 643  | 638     | 743  |
| 1200                | 407     | 485  | 596     | 701  | 696     | 811  |
| 1300                | 441     | 525  | 645     | 759  | 754     | 879  |
| 1400                | 475     | 566  | 695     | 818  | 812     | 946  |
| 1500                | 509     | 606  | 745     | 876  | 871     | 1014 |
| 1600                | 543     | 646  | 794     | 935  | 929     | 1081 |
| 1800                | 611     | 727  | 894     | 1052 | 1045    | 1217 |
| 2000                | 679     | 808  | 993     | 1168 | 1161    | 1352 |
| 2200                | 747     | 889  | 1092    | 1285 | 1277    | 1487 |
| 2400                | 815     | 970  | 1192    | 1402 | 1393    | 1622 |
| 2600                | 882     | 1050 | 1291    | 1519 | 1509    | 1757 |
| 2800                | 950     | 1131 | 1390    | 1636 | 1625    | 1892 |
| 3000                | 1018    | 1212 | 1489    | 1753 | 1741    | 2028 |

Watts 75/65/20 conform EN442-1: 2014: radiatoren en convectoren

| KOMPAKT             | Type 22 |      | Type 33 |      | Type 34 |      |
|---------------------|---------|------|---------|------|---------|------|
| Hoogte (mm)         | 150     | 200  | 150     | 200  | 150     | 200  |
| W/m 75/65/20 (φ50K) | 591     | 715  | 844     | 1029 | 984     | 1205 |
| n-exponent          | 1,24    | 1,25 | 1,24    | 1,26 | 1,24    | 1,26 |
| Lengte (mm)         | Watt    | Watt | Watt    | Watt | Watt    | Watt |
| 800                 | 473     | 572  | 675     | 823  | 787     | 964  |
| 900                 | 532     | 644  | 760     | 926  | 886     | 1085 |
| 1000                | 591     | 715  | 844     | 1029 | 984     | 1205 |
| 1100                | 650     | 787  | 928     | 1132 | 1082    | 1326 |
| 1200                | 709     | 858  | 1013    | 1235 | 1181    | 1446 |
| 1300                | 768     | 930  | 1097    | 1338 | 1279    | 1567 |
| 1400                | 827     | 1001 | 1182    | 1441 | 1378    | 1687 |
| 1500                | 887     | 1073 | 1266    | 1544 | 1476    | 1808 |
| 1600                | 946     | 1144 | 1350    | 1646 | 1574    | 1928 |
| 1800                | 1064    | 1287 | 1519    | 1852 | 1771    | 2169 |
| 2000                | 1182    | 1430 | 1688    | 2058 | 1968    | 2410 |
| 2200                | 1300    | 1573 | 1857    | 2264 | 2165    | 2651 |
| 2400                | 1418    | 1716 | 2026    | 2470 | 2362    | 2892 |
| 2600                | 1537    | 1859 | 2194    | 2675 | 2558    | 3133 |
| 2800                | 1655    | 2002 | 2363    | 2881 | 2755    | 3374 |
| 3000                | 1773    | 2145 | 2532    | 3087 | 2952    | 3615 |

KOMPAKT

Watts 70/55/20 conform EN442-1: 2014: radiatoren en convectoren

| KOMPAKT               | Type 22 |      | Type 33 |      | Type 34 |      |
|-----------------------|---------|------|---------|------|---------|------|
| Hoogte (mm)           | 150     | 200  | 150     | 200  | 150     | 200  |
| W/m 70/55/20 (φ42,5K) | 483     | 584  | 690     | 838  | 804     | 982  |
| n-exponent            | 1,24    | 1,25 | 1,24    | 1,26 | 1,24    | 1,26 |
| Lengte (mm)           | Watt    | Watt | Watt    | Watt | Watt    | Watt |
| 800                   | 387     | 467  | 552     | 671  | 644     | 785  |
| 900                   | 435     | 525  | 621     | 755  | 724     | 884  |
| 1000                  | 483     | 584  | 690     | 838  | 804     | 982  |
| 1100                  | 531     | 642  | 759     | 922  | 885     | 1080 |
| 1200                  | 580     | 700  | 828     | 1006 | 965     | 1178 |
| 1300                  | 628     | 759  | 897     | 1090 | 1046    | 1276 |
| 1400                  | 676     | 817  | 966     | 1174 | 1126    | 1375 |
| 1500                  | 725     | 875  | 1035    | 1258 | 1207    | 1473 |
| 1600                  | 773     | 934  | 1104    | 1342 | 1287    | 1571 |
| 1800                  | 870     | 1050 | 1242    | 1509 | 1448    | 1767 |
| 2000                  | 966     | 1167 | 1380    | 1677 | 1609    | 1964 |
| 2200                  | 1063    | 1284 | 1518    | 1845 | 1770    | 2160 |
| 2400                  | 1160    | 1401 | 1656    | 2012 | 1931    | 2356 |
| 2600                  | 1256    | 1517 | 1794    | 2180 | 2091    | 2553 |
| 2800                  | 1353    | 1634 | 1932    | 2348 | 2252    | 2749 |
| 3000                  | 1449    | 1751 | 2070    | 2515 | 2413    | 2946 |

Watts 55/45/20 conform EN442-1: 2014: radiatoren en convectoren

| KOMPAKT             | Type 22 |      | Type 33 |      | Type 34 |      |
|---------------------|---------|------|---------|------|---------|------|
| Hoogte (mm)         | 150     | 200  | 150     | 200  | 150     | 200  |
| W/m 55/45/20 (φ30K) | 314     | 378  | 448     | 541  | 522     | 633  |
| n-exponent          | 1,24    | 1,25 | 1,24    | 1,26 | 1,24    | 1,26 |
| Lengte (mm)         | Watt    | Watt | Watt    | Watt | Watt    | Watt |
| 800                 | 251     | 302  | 358     | 432  | 418     | 506  |
| 900                 | 282     | 340  | 403     | 487  | 470     | 570  |
| 1000                | 314     | 378  | 448     | 541  | 522     | 633  |
| 1100                | 345     | 415  | 493     | 595  | 575     | 696  |
| 1200                | 376     | 453  | 538     | 649  | 627     | 760  |
| 1300                | 408     | 491  | 582     | 703  | 679     | 823  |
| 1400                | 439     | 529  | 627     | 757  | 731     | 886  |
| 1500                | 471     | 566  | 672     | 811  | 783     | 950  |
| 1600                | 502     | 604  | 717     | 865  | 836     | 1013 |
| 1800                | 565     | 680  | 806     | 973  | 940     | 1140 |
| 2000                | 627     | 755  | 896     | 1081 | 1045    | 1266 |
| 2200                | 690     | 831  | 986     | 1189 | 1149    | 1393 |
| 2400                | 753     | 906  | 1075    | 1297 | 1253    | 1519 |
| 2600                | 816     | 982  | 1165    | 1406 | 1358    | 1646 |
| 2800                | 878     | 1057 | 1254    | 1514 | 1462    | 1773 |
| 3000                | 941     | 1133 | 1344    | 1622 | 1567    | 1899 |

DESIGN 1

Watts 75/65/20 conform EN442-1: 2014: radiatoren en convectoren

| DESIGN 1            | Type 22 |      | Type 33 |      | Type 34 |      |
|---------------------|---------|------|---------|------|---------|------|
| Hoogte (mm)         | 150     | 200  | 150     | 200  | 150     | 200  |
| W/m 75/65/20 (φ50K) | 591     | 688  | 848     | 1011 | 1014    | 1189 |
| n-exponent          | 1,23    | 1,25 | 1,24    | 1,27 | 1,25    | 1,25 |
| Lengte (mm)         | Watt    | Watt | Watt    | Watt | Watt    | Watt |
| 800                 | 473     | 550  | 678     | 809  | 811     | 951  |
| 900                 | 532     | 619  | 763     | 910  | 913     | 1070 |
| 1000                | 591     | 688  | 848     | 1011 | 1014    | 1189 |
| 1100                | 650     | 757  | 933     | 1112 | 1115    | 1308 |
| 1200                | 709     | 826  | 1018    | 1213 | 1217    | 1427 |
| 1300                | 768     | 894  | 1102    | 1314 | 1318    | 1546 |
| 1400                | 827     | 963  | 1187    | 1415 | 1420    | 1665 |
| 1500                | 887     | 1032 | 1272    | 1517 | 1521    | 1784 |
| 1600                | 946     | 1101 | 1357    | 1618 | 1622    | 1902 |
| 1800                | 1064    | 1238 | 1526    | 1820 | 1825    | 2140 |
| 2000                | 1182    | 1376 | 1696    | 2022 | 2028    | 2378 |
| 2200                | 1300    | 1514 | 1866    | 2224 | 2231    | 2616 |
| 2400                | 1418    | 1651 | 2035    | 2426 | 2434    | 2854 |
| 2600                | 1537    | 1789 | 2205    | 2629 | 2636    | 3091 |
| 2800                | 1655    | 1926 | 2374    | 2831 | 2839    | 3329 |
| 3000                | 1773    | 2064 | 2544    | 3033 | 3042    | 3567 |

Watts 70/55/20 conform EN442-1: 2014: radiatoren en convectoren

| DESIGN 1              | Type 22 |      | Type 33 |      | Type 34 |      |
|-----------------------|---------|------|---------|------|---------|------|
| Hoogte (mm)           | 150     | 200  | 150     | 200  | 150     | 200  |
| W/m 70/55/20 (φ42,5K) | 484     | 562  | 693     | 822  | 828     | 970  |
| n-exponent            | 1,23    | 1,25 | 1,24    | 1,27 | 1,25    | 1,25 |
| Lengte (mm)           | Watt    | Watt | Watt    | Watt | Watt    | Watt |
| 800                   | 387     | 449  | 555     | 658  | 662     | 776  |
| 900                   | 436     | 505  | 624     | 740  | 745     | 873  |
| 1000                  | 484     | 562  | 693     | 822  | 828     | 970  |
| 1100                  | 532     | 618  | 763     | 905  | 910     | 1067 |
| 1200                  | 581     | 674  | 832     | 987  | 993     | 1164 |
| 1300                  | 629     | 730  | 901     | 1069 | 1076    | 1262 |
| 1400                  | 677     | 786  | 971     | 1151 | 1159    | 1359 |
| 1500                  | 726     | 842  | 1040    | 1234 | 1241    | 1456 |
| 1600                  | 774     | 898  | 1109    | 1316 | 1324    | 1553 |
| 1800                  | 871     | 1011 | 1248    | 1480 | 1490    | 1747 |
| 2000                  | 968     | 1123 | 1386    | 1645 | 1655    | 1941 |
| 2200                  | 1065    | 1235 | 1525    | 1809 | 1821    | 2135 |
| 2400                  | 1161    | 1348 | 1664    | 1974 | 1986    | 2329 |
| 2600                  | 1258    | 1460 | 1802    | 2138 | 2152    | 2523 |
| 2800                  | 1355    | 1572 | 1941    | 2303 | 2317    | 2717 |
| 3000                  | 1452    | 1685 | 2080    | 2467 | 2483    | 2911 |

Watts 55/45/20 conform EN442-1: 2014: radiatoren en convectoren

| DESIGN 1            | Type 22 |      | Type 33 |      | Type 34 |      |
|---------------------|---------|------|---------|------|---------|------|
| Hoogte (mm)         | 150     | 200  | 150     | 200  | 150     | 200  |
| W/m 55/45/20 (φ30K) | 315     | 363  | 450     | 528  | 535     | 628  |
| n-exponent          | 1,23    | 1,25 | 1,24    | 1,27 | 1,25    | 1,25 |
| Lengte (mm)         | Watt    | Watt | Watt    | Watt | Watt    | Watt |
| 800                 | 252     | 291  | 360     | 423  | 428     | 502  |
| 900                 | 284     | 327  | 405     | 476  | 482     | 565  |
| 1000                | 315     | 363  | 450     | 528  | 535     | 628  |
| 1100                | 347     | 400  | 495     | 581  | 589     | 691  |
| 1200                | 378     | 436  | 540     | 634  | 643     | 753  |
| 1300                | 410     | 472  | 585     | 687  | 696     | 816  |
| 1400                | 441     | 509  | 630     | 740  | 750     | 879  |
| 1500                | 473     | 545  | 675     | 793  | 803     | 942  |
| 1600                | 504     | 581  | 720     | 846  | 857     | 1005 |
| 1800                | 568     | 654  | 810     | 951  | 964     | 1130 |
| 2000                | 631     | 727  | 900     | 1057 | 1071    | 1256 |
| 2200                | 694     | 799  | 990     | 1163 | 1178    | 1381 |
| 2400                | 757     | 872  | 1080    | 1268 | 1285    | 1507 |
| 2600                | 820     | 945  | 1170    | 1374 | 1392    | 1632 |
| 2800                | 883     | 1017 | 1260    | 1480 | 1499    | 1758 |
| 3000                | 946     | 1090 | 1350    | 1585 | 1606    | 1884 |



Watts 75/65/20 conform EN442-1: 2014: radiatoren en convectoren

## DESIGN 2

| DESIGN 2            | Type 22 |      | Type 33 |      | Type 34 |      |
|---------------------|---------|------|---------|------|---------|------|
| Hoogte (mm)         | 150     | 200  | 150     | 200  | 150     | 200  |
| W/m 75/65/20 (φ50K) | 573     | 684  | 827     | 999  | 965     | 1171 |
| n-exponent          | 1,23    | 1,24 | 1,22    | 1,24 | 1,22    | 1,25 |
| Lengte (mm)         | Watt    | Watt | Watt    | Watt | Watt    | Watt |
| 800                 | 458     | 547  | 662     | 799  | 772     | 937  |
| 900                 | 516     | 616  | 744     | 899  | 869     | 1054 |
| 1000                | 573     | 684  | 827     | 999  | 965     | 1171 |
| 1100                | 630     | 752  | 910     | 1099 | 1062    | 1288 |
| 1200                | 688     | 821  | 992     | 1199 | 1158    | 1405 |
| 1300                | 745     | 889  | 1075    | 1299 | 1255    | 1522 |
| 1400                | 802     | 958  | 1158    | 1399 | 1351    | 1639 |
| 1500                | 860     | 1026 | 1241    | 1499 | 1448    | 1757 |
| 1600                | 917     | 1094 | 1323    | 1598 | 1544    | 1874 |
| 1800                | 1031    | 1231 | 1489    | 1798 | 1737    | 2108 |
| 2000                | 1146    | 1368 | 1654    | 1998 | 1930    | 2342 |
| 2200                | 1261    | 1505 | 1819    | 2198 | 2123    | 2576 |
| 2400                | 1375    | 1642 | 1985    | 2398 | 2316    | 2810 |
| 2600                | 1490    | 1778 | 2150    | 2597 | 2509    | 3045 |
| 2800                | 1604    | 1915 | 2316    | 2797 | 2702    | 3279 |
| 3000                | 1719    | 2052 | 2481    | 2997 | 2895    | 3513 |

Watts 70/55/20 conform EN442-1: 2014: radiatoren en convectoren

| DESIGN 2              | Type 22 |      | Type 33 |      | Type 34 |      |
|-----------------------|---------|------|---------|------|---------|------|
| Hoogte (mm)           | 150     | 200  | 150     | 200  | 150     | 200  |
| W/m 70/55/20 (φ42,5K) | 469     | 559  | 678     | 817  | 791     | 956  |
| n-exponent            | 1,23    | 1,24 | 1,22    | 1,24 | 1,22    | 1,25 |
| Lengte (mm)           | Watt    | Watt | Watt    | Watt | Watt    | Watt |
| 800                   | 375     | 447  | 543     | 653  | 633     | 765  |
| 900                   | 422     | 503  | 610     | 735  | 712     | 860  |
| 1000                  | 469     | 559  | 678     | 817  | 791     | 956  |
| 1100                  | 516     | 615  | 746     | 898  | 871     | 1051 |
| 1200                  | 563     | 671  | 814     | 980  | 950     | 1147 |
| 1300                  | 610     | 727  | 882     | 1062 | 1029    | 1242 |
| 1400                  | 657     | 783  | 950     | 1143 | 1108    | 1338 |
| 1500                  | 704     | 839  | 1017    | 1225 | 1187    | 1434 |
| 1600                  | 751     | 895  | 1085    | 1307 | 1266    | 1529 |
| 1800                  | 845     | 1006 | 1221    | 1470 | 1425    | 1720 |
| 2000                  | 938     | 1118 | 1357    | 1633 | 1583    | 1911 |
| 2200                  | 1032    | 1230 | 1492    | 1797 | 1741    | 2103 |
| 2400                  | 1126    | 1342 | 1628    | 1960 | 1899    | 2294 |
| 2600                  | 1220    | 1454 | 1763    | 2123 | 2058    | 2485 |
| 2800                  | 1314    | 1566 | 1899    | 2287 | 2216    | 2676 |
| 3000                  | 1408    | 1677 | 2035    | 2450 | 2374    | 2867 |

Watts 55/45/20 conform EN442-1: 2014: radiatoren en convectoren

| DESIGN 2            | Type 22 |      | Type 33 |      | Type 34 |      |
|---------------------|---------|------|---------|------|---------|------|
| Hoogte (mm)         | 150     | 200  | 150     | 200  | 150     | 200  |
| W/m 55/45/20 (φ30K) | 306     | 363  | 443     | 530  | 517     | 618  |
| n-exponent          | 1,23    | 1,24 | 1,22    | 1,24 | 1,22    | 1,25 |
| Lengte (mm)         | Watt    | Watt | Watt    | Watt | Watt    | Watt |
| 800                 | 245     | 290  | 355     | 424  | 414     | 495  |
| 900                 | 275     | 327  | 399     | 477  | 466     | 557  |
| 1000                | 306     | 363  | 443     | 530  | 517     | 618  |
| 1100                | 336     | 399  | 488     | 583  | 569     | 680  |
| 1200                | 367     | 436  | 532     | 636  | 621     | 742  |
| 1300                | 397     | 472  | 576     | 689  | 673     | 804  |
| 1400                | 428     | 508  | 621     | 742  | 724     | 866  |
| 1500                | 459     | 545  | 665     | 795  | 776     | 928  |
| 1600                | 489     | 581  | 710     | 848  | 828     | 989  |
| 1800                | 550     | 653  | 798     | 954  | 931     | 1113 |
| 2000                | 611     | 726  | 887     | 1060 | 1035    | 1237 |
| 2200                | 673     | 799  | 976     | 1167 | 1138    | 1360 |
| 2400                | 734     | 871  | 1064    | 1273 | 1242    | 1484 |
| 2600                | 795     | 944  | 1153    | 1379 | 1345    | 1608 |
| 2800                | 856     | 1017 | 1242    | 1485 | 1449    | 1731 |
| 3000                | 917     | 1089 | 1330    | 1591 | 1552    | 1855 |

# KLEUREN

| NOBLE  | WHITE BLACK   | NATURAL GREY<br>MATT  | PURE GREY<br>MATT   | METALIC GREY<br>STRUCTURE   | BLUE GREEN<br>MINERAL   |
|--|---|---|---|---|---|
| <br>Pergamon<br>SAN 0019 <i>01</i>  | <br>Cream White<br>RAL 9001 <i>08</i>    | <br>Mist White<br>N500 <i>15</i>     | <br>Signal White<br>RAL 9003 <i>22</i>      | <br>Grey Aluminium<br>M307 <i>29</i>           | <br>Dark Blue<br>9801 <i>36</i>      |
| <br>Pink<br>3012 <i>02</i>          | <br>White Fine Texture<br>S600 <i>09</i> | <br>Sand Light<br>N502 <i>16</i>     | <br>Tele Grey 4<br>RAL 7047 <i>23</i>       | <br>White Aluminium<br>M306 <i>30</i>          | <br>Mid Blue<br>9802 <i>37</i>       |
| <br>Silver<br>9898 <i>03</i>       | <br>Traffic White<br>RAL 9016 <i>10</i> | <br>Sand<br>N503 <i>17</i>          | <br>Widow Grey<br>RAL 7040 <i>24</i>       | <br>Grey White January<br>M303 <i>31</i>      | <br>Grey Blue<br>9803 <i>38</i>     |
| <br>Pearl Beige<br>1035 <i>04</i> | <br>Pure White<br>RAL 9010 <i>11</i>   | <br>Platina Grey<br>N504 <i>18</i> | <br>Tele Grey 2<br>RAL 7046 <i>25</i>     | <br>Aluminium Grey January<br>M302 <i>32</i> | <br>Forest Green<br>9804 <i>39</i> |
| <br>Gold<br>9899 <i>05</i>        | <br>Brown Black<br>9826 <i>12</i>      | <br>Dust Grey<br>N505 <i>19</i>    | <br>Blue Grey<br>RAL 7031 <i>26</i>       | <br>Anthracite January<br>M301 <i>33</i>     | <br>Jade Green<br>9805 <i>40</i>   |
| <br>Curry<br>9894 <i>06</i>       | <br>Grey Anthracite<br>9827 <i>13</i>  | <br>Warm Grey<br>N506 <i>20</i>    | <br>Slate Grey<br>RAL 7015 <i>27</i>      | <br>Black January<br>M300 <i>34</i>          | <br>Grey Green<br>9806 <i>41</i>   |
| <br>Bronze<br>9893 <i>07</i>      | <br>Jet Black<br>RAL 9005 <i>14</i>    | <br>Brown Grey<br>N507 <i>21</i>   | <br>Anthracite Grey<br>RAL 7016 <i>28</i> | <br>Brown January<br>M304 <i>35</i>          | <br>Warm Green<br>9807 <i>42</i>   |

TERRA-COTTA  
MINERAL



Dark Brown  
9808 43



Rust Brown  
9809 44



Quartz Brown  
9810 45



Light Beige  
9811 46



Orange Brown  
9812 47



Blood Red  
9813 48



Purple Red  
9814 49

UNI COLOURS  
FINE TEXTURE

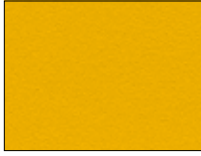

Melon Yellow  
9815 50



Carmine Red  
9816 51



Claret Violet  
9817 52



Night Blue  
9818 53

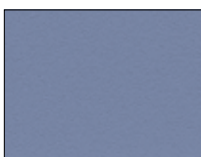

Pigeon Blue  
S601 54



Yellow Green  
9820 55



Moss Green  
9821 56

## SUPERIA KLEURT UW CV-COMFORT

Kiest u voor een kleurrijk interieur en mooi bijpassende cv-radiatoren? Superia stelt u een waaier aan frisse, eigentijdse tinten voor. Welk kleurtje u ook in gedachten hebt, Superia zorgt voor een smetteloze, kleurvaste schildering.

Naast het standaard wit zijn er ook diverse hedendaagse kleuren en structuren verkrijgbaar.

Leverbaar voor verticale en Mini radiatoren (meerprijs)

Voor horizontale radiatoren Standaard, Kompakt, Super 6, Super 6 Design, Central en Central Design (meerprijs).

Galva: niet in kleur, enkel wit (RAL 9016).

*De afgebeelde kleuren zijn slechts indicatief.*

Wenst u meer informatie over Superia radiatoren? Praat eens met een specialist. Neem contact op via [www.superia.be](http://www.superia.be) of contacteer ons via het adres op de rugzijde van deze brochure.



## Superia paneelradiatoren

info@superia.be  
[www.superia.be](http://www.superia.be)

Vasco Group nv  
Kruishoefstraat 50  
3650 Dilsen (België)  
T +32 (0)89-79 04 11  
info@vasco.eu  
[www.vasco.eu](http://www.vasco.eu)

Download de **Vasco-App**  
**Climate Control** voor uw  
binnenklimaat op maat.



Follow us on  
**Facebook** and  
**YouTube**.



01/2025 Superia kan niet verantwoordelijk gesteld worden voor mogelijke drukfouten en eventuele wijzigingen in het programma.

Verkoopsvoorwaarden [www.superia.be](http://www.superia.be)